

## [1,2]-Domination in Generalized Petersen Graphs

Firouz Beggas, Volker Turau, Mohammed Haddad, Hamamache Kheddouci

► **To cite this version:**

Firouz Beggas, Volker Turau, Mohammed Haddad, Hamamache Kheddouci. [1,2]-Domination in Generalized Petersen Graphs. 2019. hal-02166989

**HAL Id: hal-02166989**

**<https://hal.archives-ouvertes.fr/hal-02166989>**

Preprint submitted on 27 Jun 2019

**HAL** is a multi-disciplinary open access archive for the deposit and dissemination of scientific research documents, whether they are published or not. The documents may come from teaching and research institutions in France or abroad, or from public or private research centers.

L'archive ouverte pluridisciplinaire **HAL**, est destinée au dépôt et à la diffusion de documents scientifiques de niveau recherche, publiés ou non, émanant des établissements d'enseignement et de recherche français ou étrangers, des laboratoires publics ou privés.

**[1,2]-DOMINATION IN GENERALIZED PETERSEN GRAPHS\***

FIROUZ BEGGAS<sup>a</sup>, VOLKER TURAU<sup>b</sup>, MOHAMMED HADDAD<sup>a†</sup>  
 HAMAMACHE KHEDDOUCI<sup>a</sup>

<sup>a</sup>University of Claude Bernard Lyon 1, 43 Bd du 11 Novembre 1918, F-69622, Villeurbanne, France

<sup>b</sup>Institute of Telematics, Hamburg University of Technology, 21073 Hamburg, Germany, Am Schwarzenberg-Campus 3

A vertex subset  $S$  of a graph  $G = (V, E)$  is a  $[1, 2]$ -dominating set if each vertex of  $V \setminus S$  is adjacent to either one or two vertices in  $S$ . The minimum cardinality of a  $[1, 2]$ -dominating set of  $G$ , denoted by  $\gamma_{[1,2]}(G)$ , is called the  $[1, 2]$ -domination number of  $G$ . In this paper the  $[1, 2]$ -domination and the  $[1, 2]$ -total domination numbers of the generalized Petersen graphs  $P(n, 2)$  are determined.

*Keywords:* Generalized Petersen graph; Vertex domination;  $[1, 2]$ -domination;  $[1, 2]$ -total domination

**1. Introduction**

The study of domination problems in graph theory has a long history. For an undirected graph  $G = (V, E)$  a subset  $S \subseteq V$  is a *dominating set* if every vertex not in  $S$  has a neighbor in  $S$ . The *domination number*  $\gamma(G)$  is the minimum size of a dominating set in  $G$ . For many classes of graphs the exact values of  $\gamma(G)$  are known, e.g.,  $\gamma(P_n) = \gamma(C_n) = \lceil n/3 \rceil$ . Here  $P_n$  and  $C_n$  are the paths and cycle graphs respectively with  $n$  vertices. For the class of generalized Petersen graphs  $P(n, 2)$  introduced by Watkins [9] it was conjectured by Behzad et al. that  $\gamma(P(n, 2)) = \lceil 3n/5 \rceil$  holds [1]. This conjecture was later independently verified by several researchers [5,6,10].

Over the years different variations of graph domination were introduced, e.g., connected domination, independent domination, and total domination. The domination number  $\gamma(G)$  and the total domination number  $\gamma_t(G)$  of graph  $G$  are among the most well studied parameters in graph theory. Some of these domination numbers are known for generalized Petersen graphs. Cao et al. computed the total domination number of  $P(n, 2)$  as  $\gamma_t(P(n, 2)) = 2\lceil n/3 \rceil$  [2]. Further results can be found in [8,12].

This paper considers  $[1, 2]$ -domination, a concept introduced by Chellali et al. [3]. A subset  $S \subseteq V$  is a  $[1, 2]$ -*dominating set* if every vertex not in  $S$  has at least one and at most two neighbors in  $S$ , i.e.,  $1 \leq |N(v) \cap S| \leq 2$  for all  $v \in V \setminus S$ .

\*This work is supported by PHC PROCOPE 2015-2017, project id 33394TD and PPP PROCOPE 2015, project id 57134870.

†Contact author: mohammed.haddad@univ-lyon1.fr

The  $[1, 2]$ -domination number  $\gamma_{[1,2]}(G)$  is the minimum size of a  $[1, 2]$ -dominating set in  $G$ . Obviously  $\gamma(G) \leq \gamma_{[1,2]}(G)$  for any graph  $G$ . Chellali et al. proved that if  $G$  is a  $P_4$ -free graph then  $\gamma(G) = \gamma_{[1,2]}(G)$ . A characterization of graphs with this property is an open problem. More results about  $[1, 2]$ -domination can be found in [11].

This paper also deals with the  $[1, 2]$ -total domination defined as follow. A subset  $S \subseteq V$  is a  $[1, 2]$ -total dominating set if every vertex  $v$  in  $V$  has at least one and at most two neighbors in  $S$ , i.e.,  $1 \leq |N(v) \cap S| \leq 2$  for all  $v \in V$ . The  $[1, 2]$ -total domination number  $\gamma_{t[1,2]}(G)$  is the minimum size of a  $[1, 2]$ -total dominating set in  $G$ . Clearly,  $\gamma_{[1,2]}(G) \leq \gamma_{t[1,2]}(G)$  for each graph  $G$ .

In this paper we analyze the  $[1, 2]$ -domination numbers of the generalized Petersen graphs  $P(n, 2)$  and prove the following theorem.

$$\textbf{Theorem 1. } \gamma_{[1,2]}(P(n, 2)) = \begin{cases} 2n/3 & \text{if } n \equiv 0, 3[6] \\ 2\lfloor n/3 \rfloor + 1 & \text{if } n \equiv 1[6] \\ 2\lfloor n/3 \rfloor + 2 & \text{otherwise.} \end{cases} \quad \text{for } n \geq 5.$$

Note that  $\gamma_{[1,2]}(P(n, 2))$  is by a factor of  $10/9$  larger than  $\gamma(P(n, 2))$ . After that, we investigate the problem of  $[1, 2]$ -total domination and prove the following result.

$$\textbf{Theorem 2. } \gamma_{t[1,2]}(P(n, 2)) = \begin{cases} 5 & \text{if } n = 5 \\ 2n/3 & \text{if } n \equiv 0, 3[6] \\ 2\lfloor n/3 \rfloor + 2 & \text{otherwise.} \end{cases} \quad \text{for } n \geq 6.$$

Note that  $\gamma_{t[1,2]}(P(n, 2)) = \gamma_{[1,2]}(P(n, 2))$  except for the case  $n = 5$  and  $n \equiv 1[6]$ . Surprisingly  $\gamma_{t[1,2]}(P(n, 2))$  is almost equal to  $\gamma_t(P(n, 2))$ .

## 2. Notation

This paper uses standard notation from graph theory which can be found in textbooks on graph theory such as [4]. For an extended study about domination concepts the reader is referred to [7].

**Definition 1.** Let  $n, k \in \mathbb{N}$  with  $k < n/2$ . The generalized Petersen graph  $P(n, k)$  is the undirected graph with vertices  $\{u_0, \dots, u_{n-1}\} \cup \{v_0, \dots, v_{n-1}\}$  and edges  $\{(u_i, u_{i+1}), (u_i, v_i), (v_i, v_{i+k}) \mid 0 \leq i < n\}$ .

The graphs  $P(n, k)$  are regular graphs with  $2n$  vertices and  $\Delta = 3$ . The domination number  $\gamma(P(n, k))$  for some values of  $k$  are known [1,12]. In particular Ebrahimi et al. proved in [5] that  $\gamma(P(n, 2)) = \lceil \frac{3n}{5} \rceil$ .

In this paper indices are always interpreted modulo  $n$ , e.g.  $v_{n+i} = v_i$ . Fig. 1 shows the graphs  $P(5, 2)$  and  $P(6, 2)$ , vertices depicted in black form a  $[1, 2]$ -dominating set of minimum size, i.e.,  $\gamma_{[1,2]}(P(5, 2)) = \gamma_{[1,2]}(P(6, 2)) = 4$  and also for the graph  $P(5, 2)$ , vertices depicted in black form a  $[1, 2]$ -total dominating set of minimum size  $\gamma_{t[1,2]}(P(5, 2)) = 5$ .

The proofs of this paper use the following notion of a *block*.

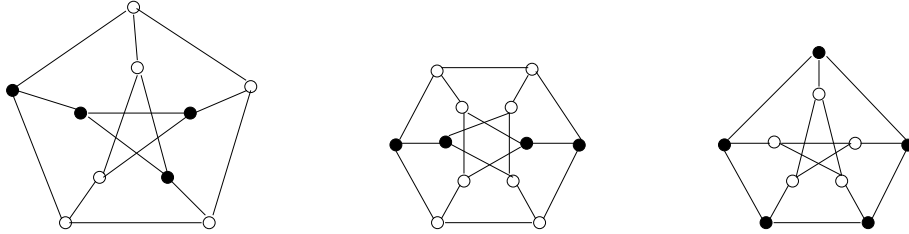

Fig. 1. The minimum [1, 2]-domination sets of the generalized Petersen graphs  $P(5, 2)$  and  $P(6, 2)$  and the minimum [1, 2]-total dominating set for  $P(5, 2)$ .

**Definition 2.** A block  $b$  of  $P(n, 2)$  is the subgraph induced by the six vertices  $\{v_{i-1}, v_i, v_{i+1}, u_{i-1}, u_i, u_{i+1}\}$  for any  $i \in \{0, \dots, n-1\}$ . A block is called positive if two of the indices of  $\{v_{i-1}, v_i, v_{i+1}\}$  are odd, otherwise it is called negative.

Fig. 2 shows a series of blocks of  $P(n, 2)$ . The second block is *positive* while the other two are *negative*. Note that blocks can overlap. If  $b$  is a block, the block to the left is denoted by  $b^-$  and that to the right by  $b^+$ .

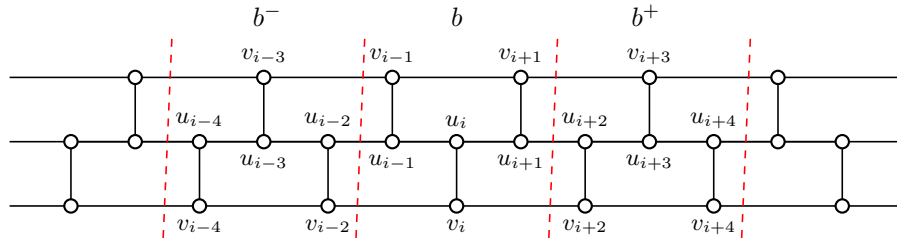

Fig. 2. Partition of  $P(n, 2)$  into blocks.

**Definition 3.** Let  $S$  be a [1, 2]-dominating set. For a subset  $U \subseteq V$  denote by  $\gamma_S(U)$  the number of vertices of  $S$  that are in  $U$ , i.e.,  $\gamma_S(U) = |U \cap S|$ . For  $i \geq 0$  let  $\mathcal{B}_i(S)$  be the set of all blocks  $b$  with  $\gamma_S(b) = i$ .

Note that  $\mathcal{B}_0(S) = \emptyset$  for any dominating set  $S$  of  $P(n, 2)$ . Denote by  $f(n)$  the value of the right side of the equation in Theorem 1. Note that  $f(n) = f(n-6) + 4$  for any  $n \geq 5$ .

### 3. Determination of $\gamma_{[1,2]}(P(n, 2))$

The correctness of Theorem 1 for  $n < 12$  can be verified manually.

**Lemma 3.**  $\gamma_{[1,2]}(P(n, 2)) = f(n)$  for  $5 \leq n < 12$ .

**Proof.** By inspection, we can easily see that the following sets  $S_n$  are minimum  $[1, 2]$ -dominating sets of  $P(n, 2)$ .  $S_5 = \{u_1, v_1, v_3, v_4\}$ ,  $S_6 = \{u_1, v_1, u_4, v_4\}$ ,  $S_7 = \{u_0, v_1, v_2, v_3, u_4\}$ ,  $S_8 = \{u_1, v_1, u_4, v_4, v_6, v_7\}$ ,  $S_9 = \{u_1, v_1, u_4, v_4, u_7, v_7\}$ ,  $S_{10} = \{u_1, v_1, u_4, v_4, u_7, v_7, u_8, v_8\}$  and  $S_{11} = \{u_1, v_1, u_4, v_4, u_7, v_7, v_9, v_{10}\}$ .  $\square$

**Lemma 4.**  $\gamma_{[1,2]}(P(n, 2)) \leq f(n)$  for  $n \geq 5$ .

**Proof.** To prove that  $f(n)$  is an upper bound of  $\gamma_{[1,2]}(P(n, 2))$ , we give in Fig. 3 the corresponding construction for each case. For  $n \equiv 0, 3[6]$ , we choose the middle pair of nodes of each block. For the cases  $n \equiv 2, 4, 5[6]$ , we do the same as the previous case by choosing the middle pair of nodes of each block. Then, we add two dominating nodes as depicted in red in Fig. 3. For the case  $n \equiv 1[6]$ , we choose two nodes from each block as shown in Fig. 3 except in the the two successive blocks preceding the block with only two nodes. In these two blocks we choose five nodes as depicted in Fig. 3. This means that we have  $2n/3$  nodes plus one additional dominating node.  $\square$

Thus, it suffices to prove that  $f(n)$  is a lower bound. Assume that there exists a minimal  $[1, 2]$ -dominating set  $S$  of  $P(n, 2)$  with  $|S| < f(n)$ . Lemma 3 yields  $n \geq 12$ . The remaining proof is split into two parts depending on whether  $\mathcal{B}_1(S)$  is empty or not.

### 3.1. Case $\mathcal{B}_1(S) = \emptyset$

The vertices of  $P(n, 2)$  are grouped into  $n$  pairs  $p_i = \{v_i, u_i\}$  as depicted in Fig. 4. Since  $\mathcal{B}_1(S) = \emptyset$  this means that for  $i = 1, \dots, n$

$$\gamma_S(p_i) + \gamma_S(p_{i+1}) + \gamma_S(p_{i+2}) \geq 2$$

(subscripts are always taken modulo  $n$ ). Note that  $\gamma_S(p_i) \leq 2$  for all  $i$ . Consider the following system of inequalities for integer valued variables  $x_0, \dots, x_{n-1}$ .

$$\begin{aligned} x_i &\leq 2 \\ x_i + x_{i+1} + x_{i+2} &\geq 2 \\ \sum_{i=0}^{n-1} x_i &< f(n) \end{aligned} \tag{3.1}$$

Note that  $x_i = \gamma_S(p_i)$  is a solution for these equations. We will show that no solution of Eq. (3.1) is induced by a  $[1, 2]$ -dominating set.

**Lemma 5.** *Let  $x$  be a solution of Eq. (3.1) with  $x_i = 2$  for some  $i$ . Let  $\hat{x} = x$  except  $\hat{x}_{i+1} = \hat{x}_{i+2} = 0$  and  $\hat{x}_{i+3} = 2$ . Then  $\hat{x}$  is a solution of Eq. (3.1) with  $\sum_{i=0}^{n-1} \hat{x}_i \leq \sum_{i=0}^{n-1} x_i$ .*

**Proof.** Obviously  $\hat{x}$  satisfies the first two sets of inequalities. Note that  $x_{i+1} + x_{i+2} + x_{i+3} \geq 2$  since  $x$  is a solution of Eq. (3.1). Thus,  $\hat{x}_{i+1} + \hat{x}_{i+2} + \hat{x}_{i+3} \leq x_{i+1} + x_{i+2} + x_{i+3}$ .  $\square$

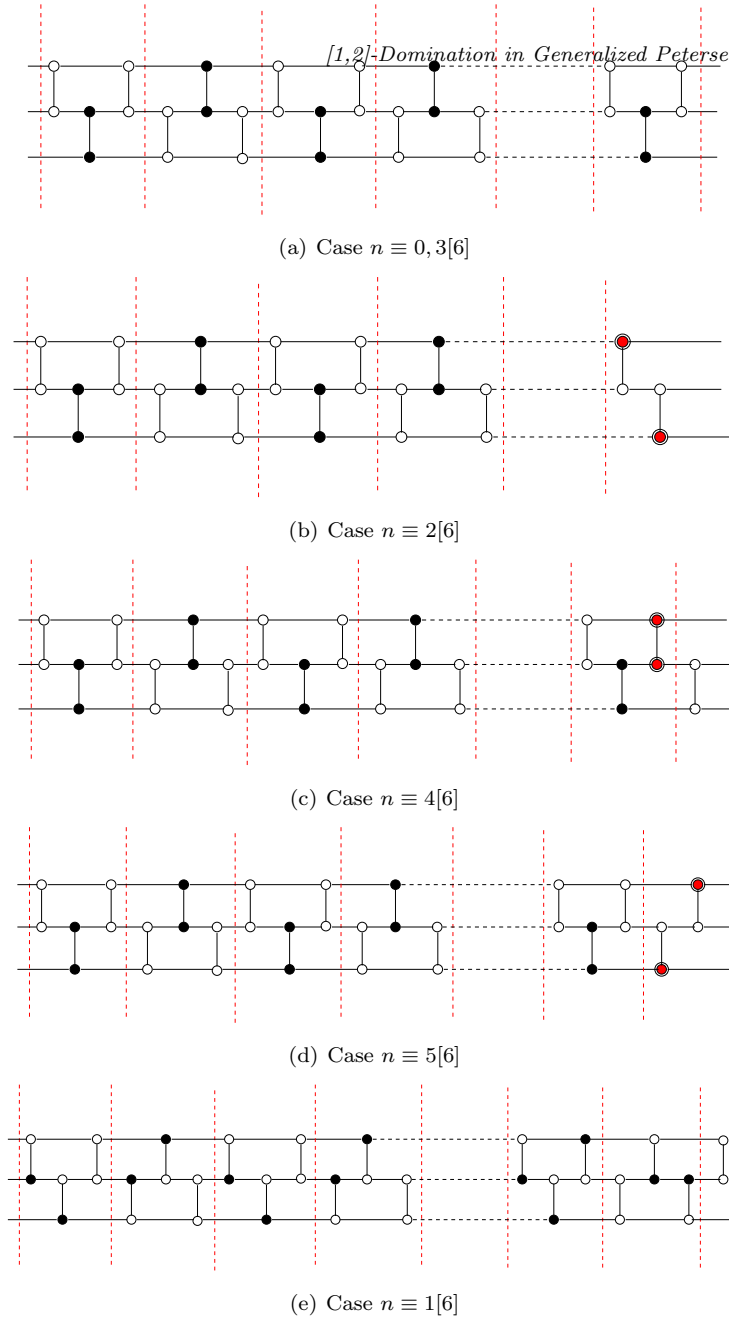

Fig. 3.  $f(n)$  is an upper bound of  $\gamma_{[1,2]}(P(n,2))$  for all  $n > 12$

**Lemma 6.** *Let  $x$  be any solution of Eq. (3.1). Then  $x_i \leq 1$  for  $i = 0, \dots, n - 1$ .*

**Proof.** Let  $x$  be any solution of Eq. (3.1) such that  $x_i = 2$  for some  $i$ . Without loss of generality  $i = 0$ . By Lemma 5 there exist a solution which coincides with  $x$  except  $x_1 = x_2 = 0$  and  $x_3 = 2$ . Repeatedly applying Lemma 5 proves that there exists a

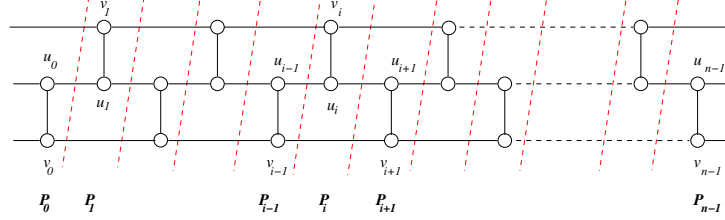

Fig. 4. The partition of  $P(n, 2)$  into  $n$  pairs.

solution  $\hat{x}$  of Eq. (3.1) with  $\hat{x}_k = 2$  and  $\hat{x}_{k+1} = \hat{x}_{k+2} = 0$  for  $k = 0, 1, \dots, \lfloor n/3 \rfloor$ . If  $n \equiv 0 [3]$  then  $\sum_{i=0}^{n-1} \hat{x}_i = 2n/3 = f(n)$ , which is impossible. Suppose  $n \equiv 1 [3]$ . Then  $\hat{x}_{n-1} = 2$  otherwise the second constraint for  $i = n - 2$  would be violated. This leads to the contradiction  $\sum_{i=0}^{n-1} \hat{x}_i = 2\lfloor n/3 \rfloor + 2 \geq f(n)$ . Hence,  $n \equiv 2 [3]$ . Then  $\hat{x}_{n-2} = 2$  otherwise the second constraint for  $i = n - 2$  is not satisfied. Again this leads to the contradiction  $\sum_{i=0}^{n-1} \hat{x}_i = 2\lfloor n/3 \rfloor + 2 = f(n)$ . This proves  $x_i \leq 1$  for all  $i$ .  $\square$

**Lemma 7.** *If  $n \not\equiv 4 [6]$  then Eq. (3.1) has no solution. If  $n \equiv 4 [6]$  then any solution of Eq. (3.1) is a rotation of the solution  $(1, 1, 0, 1, 1, 0, \dots, 1, 1, 0, 1)$ .*

**Proof.** Let  $x$  be any solution of Eq. (3.1). By Lemma 6  $x_i \leq 1$  for  $i = 0, \dots, n - 1$ . Denote by  $n_0$  the number of variables with  $x_i = 0$ . Thus  $\sum_{i=0}^{n-1} x_i = n - n_0$ . Note that if  $x_i = 0$  then either  $x_{i+1} = 1$  or  $x_{i-1} = 1$ , thus no adjacent variables have both value 0. Denote by  $l_1, \dots, l_{n_0}$  the lengths of maximal sequences of consecutive  $x_i$  with  $x_i = 1$ . Note that  $l_j \geq 2$  for all  $j$ . Then

$$\sum_{i=0}^{n-1} x_i = \sum_{j=1}^{n_0} l_j = 2n_0 + \sum_{j=1}^{n_0} (l_j - 2).$$

This implies

$$3 \sum_{i=0}^{n-1} x_i = 2n + \sum_{j=1}^{n_0} (l_j - 2).$$

If  $n \equiv 0 [3]$  then  $\sum_{i=0}^{n-1} x_i \geq 2n/3 = f(n)$ . A contradiction. If  $n \equiv 2 [3]$  then again this leads to the contradiction  $\sum_{i=0}^{n-1} x_i = 2\lfloor n/3 \rfloor + (4 + \sum_{j=1}^{n_0} (l_j - 2))/3 \geq 2\lfloor n/3 \rfloor + 2 \geq f(n)$ . Finally if  $n \equiv 1 [6]$  then  $\sum_{i=0}^{n-1} x_i = 2\lfloor n/3 \rfloor + (2 + \sum_{j=1}^{n_0} (l_j - 2))/3 \geq 2\lfloor n/3 \rfloor + 1 = f(n)$ . This contradiction proves that for  $n \not\equiv 4 [6]$  Eq. (3.1) has no solution.

Let  $n \equiv 4 [6]$ . Then  $\sum_{i=0}^{n-1} x_i = 2\lfloor n/3 \rfloor + (2 + \sum_{j=1}^{n_0} (l_j - 2))/3 < f(n) = 2\lfloor n/3 \rfloor + 1$  implies  $3 = 2 + \sum_{j=1}^{n_0} (l_j - 2)$ . This yields that there exists  $i$  such that  $l_i = 3$  and  $l_j = 2$  for all  $j \neq i$ . Thus,  $x$  is a rotation of the solution  $(1, 1, 0, 1, 1, 0, \dots, 1, 1, 0, 1)$   $\square$

**Lemma 8.** *The solution  $x = (1, 1, 0, 1, 1, 0, \dots, 1, 1, 0, 1)$  is not induced by a [1, 2]-dominating set of  $P(n, 2)$ .*

**Proof.** Assume there exists a [1, 2]-dominating set  $S$  such that  $x_i = \gamma_S(b_i)$ . Two vertices of the first two pairs must be in  $S$ . All four possibilities lead to a contradiction as shown in the following.

Case 1.  $v_0, u_1 \in S$  (see Fig. 5). Since  $S$  is [1, 2]-dominating the lower vertex of the last pair  $p_{n-1}$  must be in  $S$ . Now the same argument implies that the middle vertex of pair  $p_3$  must be in  $S$ . This yields that the lower vertex of pair  $p_7$  must be in  $S$ , otherwise the lower vertex of pair  $p_5$  is not dominated. Repeating this argument shows that the lower vertex of pair  $p_{n-3}$  must be in  $S$  (note that  $n \equiv 4 [6]$ ). Thus,  $S$  does not dominate the middle vertex of pair  $p_{n-2}$ . Contradiction.

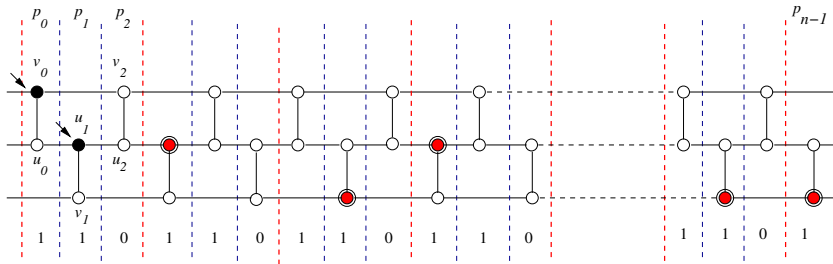

Fig. 5. If  $v_0, u_1 \in S$  then vertices depicted in red must also be in  $S$ .

Case 2.  $u_0, v_1 \in S$  (see Fig. 6). In order to dominate the middle vertex of pair  $p_2$  the middle vertex of  $p_3$  must be in  $S$ . Similarly the lower vertex of pair  $p_7$  must be in  $S$  to dominate the lower vertex of  $p_5$ . This results in the pattern shown in Fig. 6. This is impossible because all three neighbors of the lower vertex of  $p_{n-1}$  are in  $S$ .

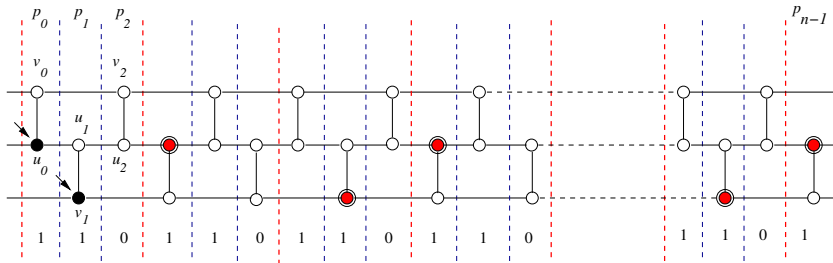

Fig. 6. If  $u_0, v_1 \in S$  then vertices depicted in red must also be in  $S$ .

Case 3.  $u_0, u_1 \in S$ . The same reasoning as above leads to the situation depicted in Fig. 7. This gives also rise to a contradiction since the upper vertex of pair  $p_{n-2}$



is not dominated.

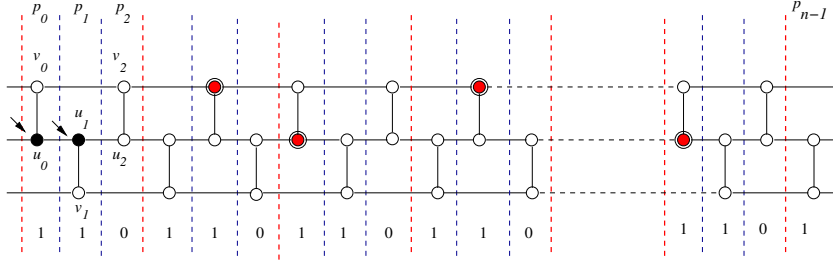

Fig. 7. If  $u_0, u_1 \in S$  then vertices depicted in red must also be in  $S$ .

Case 4.  $v_0, v_1 \in S$ . The same reasoning as above leads to the situation depicted in Fig. 8. This is impossible because all three neighbors of the lower vertex of  $p_{n-1}$  are in  $S$ .

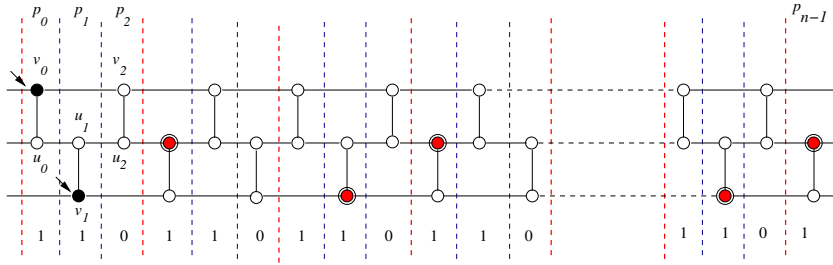

Fig. 8. If  $v_0, v_1 \in S$  then vertices depicted in red must also be in  $S$ .

□

This concludes the proof of Theorem 1 for the case  $\mathcal{B}_1(S) = \emptyset$ .

### 3.2. Case $\mathcal{B}_1(S) \neq \emptyset$

The following simple observation is based on the fact that the central vertex of a block  $b$  can only be dominated by a vertex within  $b$ .

**Lemma 9.** *Any positive block  $b \in \mathcal{B}_1(S)$  corresponds to one of the four blocks shown in Fig. 9. A similar result holds for negative blocks.*

In the following the four different types of blocks are considered individually.

**Lemma 10.** *Let  $S$  be a  $[1, 2]$ -dominating set of  $P(n, 2)$  containing a block  $b$  of type  $B$  and  $n \geq 12$ . Then there exists a  $[1, 2]$ -dominating set  $S'$  of  $P(n, 2)$  not containing a block of type  $B$  such that  $|S'| = |S|$ .*

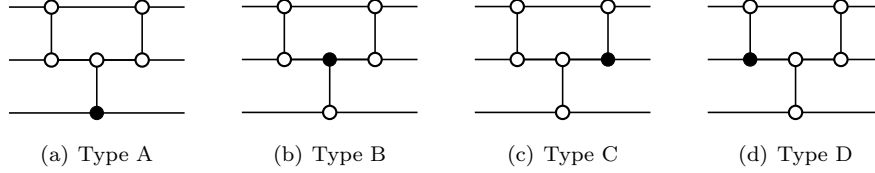

Fig. 9. The four types of positive blocks with  $\gamma_S(b) = 1$ .

**Proof.** In order to dominate  $v_{i-1}$  and  $v_{i+1}$  from block  $b$ , vertices  $v_{i-3}$  from block  $b^-$  and  $v_{i+3}$  from  $b^+$  need to be in  $S$ . The idea is to move some dominating nodes such that block  $b$  is not no longer of type B and no new block of type B emerges while  $S$  is still [1,2]-dominating and the cardinality of  $S$  remains. The proof is divided into four cases, considering whether  $u_{i-2}$  from block  $b^-$  and  $u_{i+2}$  from  $b^+$  are in  $S$  or not. The notation of the nodes is taken from Fig. 2.

Case 1.  $u_{i-2}, u_{i+2} \in S$ . If  $v_{i-4}$  and  $v_{i+4}$  are not in  $S$  then  $S' = S/\{u_i\} \cup \{v_i\}$ . If  $v_{i-4}$  or  $v_{i+4}$  are in  $S$  then  $S' = S/\{u_{i-2}\} \cup \{u_{i-1}\}$  or  $S' = S/\{u_{i+2}\} \cup \{u_{i+1}\}$ .

Case 2.  $u_{i-2} \notin S, u_{i+2} \in S$ . To dominate  $u_{i-2}$  and  $v_{i-2}$  we consider two subcases.

Subcase 2.1.  $v_{i-2} \in S$ . If  $u_{i-3}$  is not in  $S$  then  $S' = S/\{u_i\} \cup \{u_{i-1}\}$ . If  $u_{i-3} \in S$  then there are three possibilities depending on which vertex dominates  $u_{i+4}$ . Hence, if  $u_{i+3} \in S$  then  $S' = S/\{u_{i+2}\} \cup \{v_i\}$ . If  $v_{i+4} \in S$  then  $S' = S/\{u_{i+2}\} \cup \{u_{i+1}\}$ . Otherwise, the vertex  $u_{i+4}$  is dominated by node  $u_{i+5}$  of block  $b^{++}$  then  $S' = S/\{u_i\} \cup \{v_{i-1}\}$ .

Subcase 2.2.  $v_{i-2} \notin S$ . This implies that  $u_{i-3}$  and  $v_{i-4}$  from are both in  $S$ . Then  $S' = S/\{u_{i-3}\} \cup \{u_{i-1}\}$ .

Case 3.  $u_{i+2} \notin S, u_{i-2} \in S$ . This case is symmetric to case 2.

Case 4.  $u_{i+2}, u_{i-2} \notin S$ . In order to dominate  $u_{i-2}$  and  $v_{i-2}$  two situations must be considered.

Subcase 4.1.  $v_{i-2} \in S$ . Since  $v_{i-2}$  is in  $S$  and  $v_i$  is not in  $S$  then  $v_{i+2}$  cannot be a dominating node. This yields that  $u_{i+3}$  and  $v_{i+4}$  are in  $S$ . Then  $S' = S/\{u_{i+3}\} \cup \{u_{i+1}\}$ .

Subcase 4.2.  $v_{i-2} \notin S$ . This implies  $u_{i-3}, v_{i-4} \in S$ . Therefore,  $S' = S/\{u_{i-3}\} \cup \{u_{i-1}\}$ .  $\square$

The next Lemma finally completes the proof of Theorem 1.

**Lemma 11.** *If  $\mathcal{B}_1(S) \neq \emptyset$  and  $n \geq 6$  then  $|S| \geq f(n)$ .*

**Proof.** Let  $n$  be minimal such that the lemma is false. Then  $n \geq 12$  by Lemma 3. Let  $\mathcal{S}_B$  the set of all [1,2]-dominating sets  $S$  of  $P(n, 2)$  not containing a block of type B and  $|S| < f(n)$ . Then  $\mathcal{B}_1(S) \neq \emptyset$  for all  $S \in \mathcal{S}_B$  by the first part of the proof. Let  $p$  be the largest number such that  $|\mathcal{B}_1(S)| \geq p$  for each  $S \in \mathcal{S}_B$ . Then  $p \geq 1$ . Let  $\mathcal{M}_p$  be the set of all  $S \in \mathcal{S}_B$  with  $|\mathcal{B}_1(S)| = p$ .

**Claim 1:**  $P(n, 2)$  does not contain a block of type A for any  $S \in \mathcal{M}_p$ .

Assume false. Let  $S \in \mathcal{M}_p$  and  $b$  a positive block of type A. Then the nodes  $v_{i+3}$  and  $u_{i+2}$  of  $b^+$  must be dominating. Assume  $\gamma_{b^+}(S) \geq 3$ . Then  $S' = S \setminus \{u_{i+2}\} \cup \{u_i\}$  is also a  $[1, 2]$ -dominating set. Thus,  $\gamma_b(S') = 2$ . Then  $|\mathcal{B}_1(S')| = |\mathcal{B}_1(S)| - 1 < p$  since  $\gamma_b(S) = 1$ . This yields  $S' \notin \mathcal{S}_B$  and therefore  $\mathcal{B}_1(S) = \emptyset$ . Thus,  $\gamma_{b^+}(S) = 2$ .

Let  $b^{++}$  be the positive block to the right of  $b^+$ . Then the nodes  $u_{i+5}$  and  $v_{i+6}$  of  $b^{++}$  must be dominating. Next we remove the nodes of the blocks  $b$  and  $b^+$  and connect the corresponding nodes of blocks  $b^-$  and  $b^{++}$ . The resulting graph is isomorphic to  $P(n - 6, 2)$ . Furthermore,  $S' = S \setminus \{v_i, u_{i+2}, v_{i+3}, u_{i+5}\}$  is a  $[1, 2]$ -dominating set of this graph. Thus,  $|S'| = |S| - 4 \geq f(n - 6)$  by the choice of  $n$ . Therefore  $|S| \geq f(n - 6) + 4 = f(n)$ . This implies  $|S| \geq f(n)$ . This contradiction proves claim 1 for positive blocks of type A. The same argument shows that there are no negative blocks of type A.

**Claim 2:**  $P(n, 2)$  does not contain a block of type D for any  $S \in \mathcal{M}_p$

Assume false. As above we only need to consider the positive case. Let  $S \in \mathcal{M}_p$  and  $b$  a positive block of type D. Then nodes  $v_{i+3}$  and  $u_{i+2}$  of  $b^+$  must be dominating. Assume  $\gamma_{b^+}(S) = 2$ . Then again the nodes  $u_{i+5}$  and  $v_{i+6}$  of block  $b^{++}$  must be dominating. We distinguish two cases. If  $v_{i-2}$  is not a dominating node then  $S' = S \setminus \{v_{i+3}\} \cup \{v_{i+1}\}$  else ( $v_{i-2}$  is a dominating node) then we have again two subcases depending on  $\gamma_{b^{++}}(S)$ . If  $\gamma_{b^{++}}(S) = 2$  then the nodes  $u_{i+8}$  and  $v_{i+9}$  of the block to the right of  $b^{++}$  must be dominating nodes. We remove the nodes of the blocks  $b$  and  $b^+$  and connect the corresponding nodes of blocks  $b^-$  and  $b^{++}$  with  $S' = S \setminus \{u_{i-1}, u_{i+2}, v_{i+3}, v_{i+6}\}$ . Similar to the proof of claim 1 this leads to a contradiction. If  $\gamma_c(S) \geq 3$  then at least one of the nodes  $v_{i+5}$  and  $u_{i+6}$  is a dominating node. Then we again remove the nodes of the blocks  $b$  and  $b^+$  and connect the corresponding nodes of blocks  $b^-$  and  $b^{++}$  with  $S' = S \setminus \{u_{i-1}, u_{i+2}, v_{i+3}, u_{i+5}\}$ . Similar to the proof of claim 1 this leads to a contradiction.

Hence,  $\gamma_{b^+}(S) \geq 3$ . In the following we will construct a new  $[1, 2]$ -dominating set  $S'$  with  $|\mathcal{B}_1(S')| < p$ . This is a contradiction.

Case 1.  $v_{i+2}, u_{i+3} \in S$ . There are three subcases. If  $v_{i-3} \notin S$  then  $S' = S \setminus \{u_{i+2}\} \cup \{v_{i+1}\}$  and if  $v_{i-2} \notin S$  then  $S' = S \setminus \{u_{i+2}\} \cup \{u_i\}$ . If  $v_{i-3}, v_{i-2} \in S$  then  $S' = S \setminus \{u_{i-1}, u_{i+2}\} \cup \{u_i, v_i\}$ .

Case 2. Neither  $v_{i+2}$  nor  $u_{i+3}$  are in  $S$ . Since  $\gamma_{b^+}(S) \geq 3$  this implies that  $v_{i+4}$  is a dominating node and  $S' = S \setminus \{u_{i+2}\} \cup \{u_{i+1}\}$ .

Case 3. If  $v_{i+2} \in S$  and  $u_{i+3} \notin S$  then  $S' = S \setminus \{u_{i+2}\} \cup \{u_{i+1}\}$ .

Case 4. If  $v_{i+2} \notin S$  and  $u_{i+3} \in S$  we distinguish two cases: If  $v_{i+4} \in S$  then  $S' = S \setminus \{u_{i+2}\} \cup \{u_{i+1}\}$  else we have four subcases depending on which node dominates  $u_{i+5}$ :

- (1) If  $v_{i+5} \in S$  then  $S' = S \setminus \{v_{i+3}\} \cup \{u_{i+1}\}$ .
- (2) If  $u_{i+5} \in S$  then  $S' = S \setminus \{u_{i+3}\} \cup \{u_{i+1}\}$ .
- (3) If  $u_{i+6} \in S$  then we distinguish three cases depending on which node dominates  $v_{i+4}$ . If  $u_{i+4} \in S$  then  $S' = S \setminus \{u_{i+2}, u_{i+4}\} \cup \{v_{i+2}, u_i\}$ . If  $v_{i+4} \in S$  then

$S' = S \setminus \{u_{i+2}, v_{i+4}\} \cup \{v_{i+2}, u_i\}$ . Finally if  $v_{i+6} \in S$  then we remove the nodes of the blocks  $b$  and  $b^+$  and connect the corresponding nodes of blocks  $b^-$  and  $c$ .  
 (4) If  $u_{i+4} \in S$  then  $S' = S \setminus \{u_{i+2}, u_{i+3}\} \cup \{u_{i+1}, v_{i+4}\}$ .

This proves claim 2.

**Claim 3:**  $P(n, 2)$  does not contain a block of type C for any  $S \in \mathcal{M}_p$

This case is symmetric to the second claim.

**Claim 4:**  $P(n, 2)$  does not contain a block of type B for any  $S \in \mathcal{M}_p$

If  $S$  contains a block of type B then by Lemma 10 there exists  $S' \in \mathcal{S}_B$  which does not contain a block of type B. The above claims yield  $\mathcal{B}_1(S') = \emptyset$ . This contradiction concludes the proof of the lemma.  $\square$

#### 4. Determination of $\gamma_{t[1,2]}(P(n, 2))$

In this section, we analyze the [1,2]-total dominating sets of  $P(n, 2)$  and prove the Theorem 2. For the case  $n = 5$  we refer to Fig. 2. We split the proof into two lemmata. Denote by  $g(n)$  the value of the right side of the equation in Theorem 2.

**Lemma 12.**  $\gamma_{t[1,2]}(P(n, 2)) \leq g(n)$  for  $n > 5$ .

**Proof.** In Fig. 12, we give the construction of the minimum [1,2]-total dominating set in  $P(n, 2)$  for  $n \equiv 1[6]$ . The proposed construction is based on the selection of one pair of nodes of the middle in each block which corresponds to  $2n/3$  nodes. Then, we add two additional dominating nodes as depicted in color red in Fig. 12. For all other cases we refer to Fig. 3 since the provided sets are already total dominating sets.  $\square$

**Lemma 13.**  $\gamma_{t[1,2]}(P(n, 2)) \geq g(n)$  for  $n > 5$ .

**Proof.** For  $n \not\equiv 1[6]$  this follows from Theorem 1. It remains to consider the case  $n \equiv 1[6]$ . Let  $S$  be a total [1,2]-dominating set of minimum size of  $P(2, n)$  with  $|S| < g(n)$ . Let  $G[S]$  be subgraph induced by  $S$ . By definition of a [1,2]-total dominating set, each connected component of  $G[S]$  has at least two vertices and every vertex of  $G[S]$  has degree 1 or 2. Hence, every connected component is either a path or a cycle. Let  $x_l$  and  $y_l$  be the numbers of connected components that are paths and cycles of order  $l$ , respectively. Observe that  $x_1 = 0$  and  $y_1 = \dots = y_4 = 0$ . Moreover, each path of order  $l$  dominates at most  $2l + 2$  vertices and each cycle of  $l$  vertices dominates at most  $2l$  vertices. Thus,

$$\sum_{l \geq 2} (2l + 2)x_l + 2ly_l \geq 2n \tag{4.1}$$

$$\sum_{l \geq 2} l(x_l + y_l) = |S| \tag{4.2}$$

12 *F. Beggas, V. Turau, M. Haddad and H. Kheddouci*

From (4.1) and (4.2) we can deduce

$$|S| + \sum_{l \geq 2} x_l \geq n \tag{4.3}$$

Also observe that

$$\sum_{l \geq 2} lx_l \geq 2 \sum_{l \geq 2} x_l \tag{4.4}$$

Let  $n = 6k + 1$ . Then  $g(n) = 4k + 2$  and  $|S| < 4k + 2$ . Inequality (4.3) becomes  $|S| + \sum_{l \geq 2} x_l \geq 6k + 1$ , thus  $\sum_{l \geq 2} x_l \geq 2k$ . From (4.2) and using (4.4), we obtain  $4k \leq \sum_{l \geq 2} lx_l + \sum_{l \geq 2} ly_l \leq 4k + 1$ . This implies  $\sum_{l \geq 2} ly_l = 0$ , thus  $4k \leq |S| = \sum_{l \geq 2} lx_l \leq 4k + 1$ . Since  $\sum_{l \geq 2} lx_l \leq 4k + 1$  and  $\sum_{l \geq 2} x_l \geq 2k$ , we have  $\sum_{l \geq 2} lx_l \leq 2 \sum_{l \geq 2} x_l + 1$ . This is only possible if  $x_3 = 1$  and  $x_j = 0$  for all  $j > 3$ . Thus,  $G[S]$  is the union one path  $P_3$  and  $x_2$  paths  $P_2$ . Since every  $P_2$ -component can dominate at most 6 vertices and the  $P_3$ -component can dominate at most 8 vertices, we deduce  $6x_2 + 8 \geq 12k + 2 = 2n$ . On the other hand, recall  $|S| = 2x_2 + 3 \leq 4k + 1$  thus  $6x_2 + 8 \leq 12k + 2$ . Hence,  $6x_2 + 8 = 12k + 2$ . This implies that  $P(n, 2)$  can be partitioned into  $x_2$  components as shown in Fig. 10(a) and one component shown in Fig. 10(b). Suppose such a partitioning exists. In the following we study the partitioning by making consecutive extractions of components. Extracting a component means deleting all its vertices from the graph. Moreover, an extraction is said to be *forced* if there is no other option. Recall that the set of vertices of  $P(n, 2)$  is the union of the two sets  $U = \{u_0, \dots, u_{n-1}\}$  and  $V = \{v_0, \dots, v_{n-1}\}$ . Vertices of  $U$  and  $V$  form the two main cycles of  $P(n, 2)$  respectively. Either all three vertices of the  $P_3$ -component are on the same main cycle or two of them are on one cycle and the third on the other. In the first case, once the  $P_3$  dominated component is extracted, the next forced extraction of a  $P_2$  dominated component would imply the appearance of a vertex with a degree 2 (see Fig. 11(a)). In the second case, after extracting the  $P_3$  dominated component and after several forced extractions of  $P_2$  dominated components (see Fig. 11(b)), it becomes obvious that such a partitioning is impossible. Hence  $x_3 = 0$ , a contradiction.  $\square$

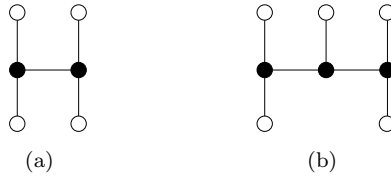

Fig. 10. Maximal components induced by  $P_2$  and  $P_3$  and their neighbors.

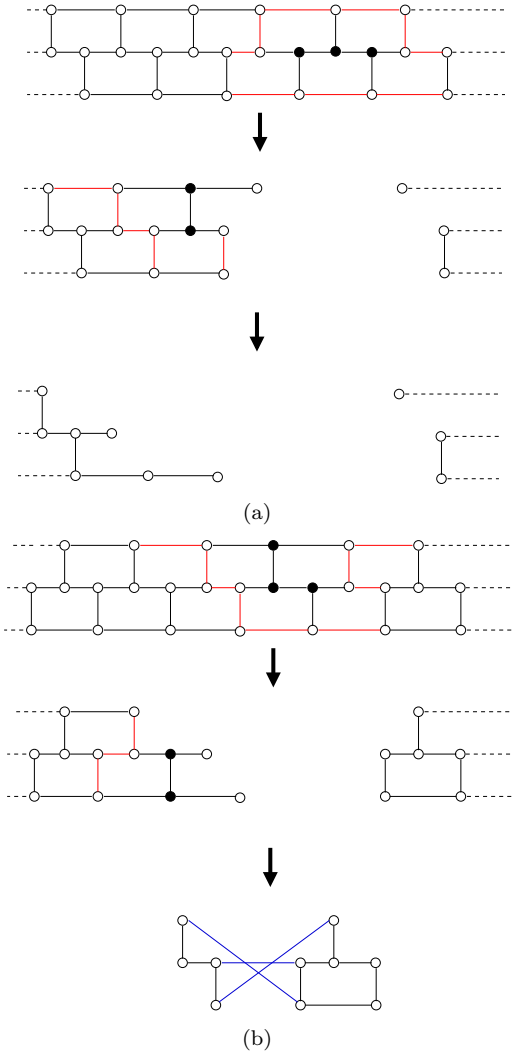

Fig. 11. Impossible partitionings.

### 5. Conclusion

Generalized Petersen graphs are very important structures in computer science and communication techniques since their particular structures and interesting properties. In this paper, we considered a variant of the dominating set problem, called the  $[1, 2]$ -dominating set problem. We studied this problem in generalized Petersen graphs  $P(n, k)$  for  $k = 2$ . We gave the exact values of the  $[1, 2]$ -domination numbers and the  $[1, 2]$ -total domination numbers of  $P(n, 2)$ . Obviously  $\gamma_{[1,2]}(P(n, 1)) = \gamma(P(n, 1))$  and so as future work we suggest to study the  $[1, 2]$ -

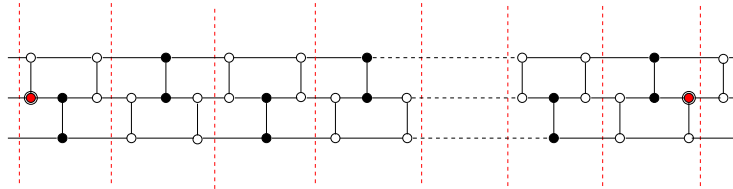

Fig. 12. The construction of  $\gamma_{t[1,2]}(P(n, 2))$  for  $n \equiv 1[6]$ .

domination numbers of  $P(n, k)$  with  $k \geq 3$ .

### References

- [1] Arash Behzad, Mehdi Behzad, and Cheryl Praeger. On the domination number of the generalized Petersen graphs. *Discrete Mathematics*, 308(4):603 – 610, 2008.
- [2] Jianxiang Cao, Weiguo Lin, and Minyong Shi. Total domination number of generalized Petersen graphs. *Intelligent Information Management*, 1(1):14–17, 2009.
- [3] Mustapha Chellali, Teresa W. Haynes, Stephen T. Hedetniemi, and Alice McRae. [1,2]-sets in graphs. *Discrete Applied Mathematics*, 161(18):2885 – 2893, 2013.
- [4] Reinhard Diestel. *Graph Theory, 4th Edition*, volume 173 of *Graduate Texts in Mathematics*. Springer, 2012.
- [5] B. Javad Ebrahimi, Nafiseh Jahanbakht, and E. Mahmoodian. Vertex domination of generalized Petersen graphs. *Discrete Mathematics*, 309(13):4355 – 4361, 2009.
- [6] Xueliang Fu, Yuansheng Yang, and Baoqi Jiang. On the domination number of generalized Petersen graphs  $P(n, 2)$ . *Discrete Mathematics*, 309(8):2445 – 2451, 2009.
- [7] T.W. Haynes, S.T. Hedetniemi, and P.J. Slater. *Fundamentals of Domination in Graphs*. Marcel Dekker, 1998.
- [8] Wen-Sheng Li, Hua-Ming Xing, and Moo Young Sohn. On the Signed Total Domination Number of Generalized Petersen Graphs  $P(n, 2)$ . *Bulletin of the Korean Mathematical Society*, 60(6):2021 – 2026, 2013.
- [9] Mark Watkins. A theorem on Tait colorings with an application to generalized Petersen graphs. *J. of Combinatorial Theory*, 6(2):152 – 164, 1969.
- [10] Hong Yan, Liying Kang, and Guangjun Xu. The exact domination number of the generalized Petersen graphs. *Discrete Mathematics*, 309(8):2596 – 2607, 2009.
- [11] Xiaojing Yang and Baoyindureng Wu. [1,2]-domination in graphs. *Discrete Applied Mathematics*, 175:79 – 86, 2014.
- [12] Bohdan Zelinka. Domination in generalized Petersen graphs. *Czechoslovak Mathematical Journal*, 52(1):11–16, 2002.