



HAL
open science

Performance impact of honing dynamics on surface finish of precoated cylinder bores

Mohamed El Mansori, Benoit Goeldel, Leila Sabri

► **To cite this version:**

Mohamed El Mansori, Benoit Goeldel, Leila Sabri. Performance impact of honing dynamics on surface finish of precoated cylinder bores. *Surface and Coatings Technology*, 2013, 215, pp.334-339. 10.1016/j.surfcoat.2012.09.062 . hal-00965833

HAL Id: hal-00965833

<https://hal.science/hal-00965833>

Submitted on 17 Apr 2014

HAL is a multi-disciplinary open access archive for the deposit and dissemination of scientific research documents, whether they are published or not. The documents may come from teaching and research institutions in France or abroad, or from public or private research centers.

L'archive ouverte pluridisciplinaire **HAL**, est destinée au dépôt et à la diffusion de documents scientifiques de niveau recherche, publiés ou non, émanant des établissements d'enseignement et de recherche français ou étrangers, des laboratoires publics ou privés.



Science Arts & Métiers (SAM)

is an open access repository that collects the work of Arts et Métiers ParisTech researchers and makes it freely available over the web where possible.

This is an author-deposited version published in: <http://sam.ensam.eu>
Handle ID: <http://hdl.handle.net/10985/7883>

To cite this version :

Benoit GOELDEL, Mohamed EL MANSORI, Leila SABRI - Performance impact of honing dynamics on surface finish of precoated cylinder bores - Surface and Coatings Technology - Vol. 215, p.334-339 - 2013

Any correspondence concerning this service should be sent to the repository

Administrator : archiveouverte@ensam.eu

Performance impact of honing dynamics on surface finish of precoated cylinder bores

Mohamed El Mansori ^{a,1}, Benoit Goeldel ^{b,*}, Leila Sabri ^{b,2}

^a Arts & Métiers Paris Tech, LMPF, EA 4106, Rue Saint Dominique BP 508, 51006 Châlons-en-Champagne, France

^b Renault SAS, CTR, 67, rue des Bons Raisins, 92508 Rueil Malmaison cedex, France

A B S T R A C T

The surface modification of engine cylinder bores with improved sliding properties is often produced by the honing process. This multi-stage process is performed using abrasive stones loaded against the bore with simultaneous rotation and oscillation. To guarantee this process robustness with acceptable dimensional accuracy and surface quality, the stone dynamic effects in continuous balanced contact with the workpiece have to be studied deeply. This paper highlights these effects on honed surface textures. The stone dynamic behavior was studied at conventional regime ranged from 0.5 g to 1.5 g as often used in mass production. In this range, the dimensional accuracy is ensured by opposition to the surface appearance. However, higher accelerations up to 2.5 g improve simultaneously the form quality (especially straightness) and reduce the cycle time. This work shows, at least, that the bore surface finish can be dynamically controlled while honing. This technology is enabled by a micro scale regeneration mechanism of abrasive stones.

Keywords:

Honing
Cylinder liner
Surface finish
Surface aspect

1. Introduction

Minimization of friction is a major concern for internal combustion engine designers. In order to reduce losses through friction, a frequent strategy involves modifying the topography of the contact surface between the cylinder bores and the piston segments. The essential role of this interface is to ensure the lubrication of the piston slide and the tightness of the combustion chamber. Thus, oil consumption and greenhouse gas emissions are decreased with increasing engine life and its durability [1]. Manufacturing of efficient and long-lasting engines depends on reaching the essential challenge related to the generation of optimal textured surface. The cylinder liner must fulfill requirements linked to shaping, roughness, and surface aspect. The shape quality is given by roundness, straightness and cylindricity defaults. The micro-geometry of the cylinder liner is rated through its bearing area ratio [2]. The surface aspect, observed under a microscope, presents a cross grooved texture [3].

To manufacture this kind of honing, texture the finishing process is chosen by engine manufacturers to hold uniform quality of surface on mass production lines. Industrial honing machines use abrasive stones against the cylinder bore on 3 axes: rotation, axial translational motion, and radial expansion motion [4]. The texture is obtained by the crosshatching of grooves formed by the motion of the abrasive stones during the cycle.

The translational motion is carried out at a constant, alternated speed, creating a stroke motion. The length of the stroke motion is calculated such that the honing tool is higher than the stones by a third at the high inversion point and at the low inversion point. For the linear part of the motion, the grooving angle, α and the cutting speed V_c of the abrasive stones are fixed to obtain the right texture with the best performances of the process [5]. The peripheral speed V_p and the stroke speed V_b (Fig. 1) can be defined as follows:

$$\tan\left(\frac{\alpha}{2}\right) = \frac{V_b}{V_p} \quad (1)$$

$$V_c = \sqrt{V_b^2 + V_p^2}. \quad (2)$$

At the end of the process, the cutting speed and the groove angle can no longer be maintained because the direction of the motion has to be inverted. The duration Δt of this phase and the distance covered Δz depend on the inversion acceleration Γ as shown below:

$$\Delta t = \frac{2 \cdot V_b}{\Gamma} \quad (3)$$

$$\Delta z = \frac{V_b^2}{2 \cdot \Gamma}. \quad (4)$$

The user may adjust the inversion acceleration of the stroke motion between 0 and 3 g. The stroke motion actuators are more and more efficient and expensive. The latest honing machines fitted with linear engines can reach an inversion acceleration of 5 g. This study investigates the influence of the acceleration parameter on

* Corresponding author. Tel.: +33 1 768 72 380; fax: +33 1 768 69 723.

E-mail addresses: mohamed.elmansori@ensam.eu (M. El Mansori), benoit.goeldel@renault.com (B. Goeldel), leila.sabri@renault.com (L. Sabri).

¹ Tel.: +33 4 42 93 82 64; fax: +33 3 26 69 91 97.

² Tel.: +33 1 768 72 380; fax: +33 1 768 69 723.

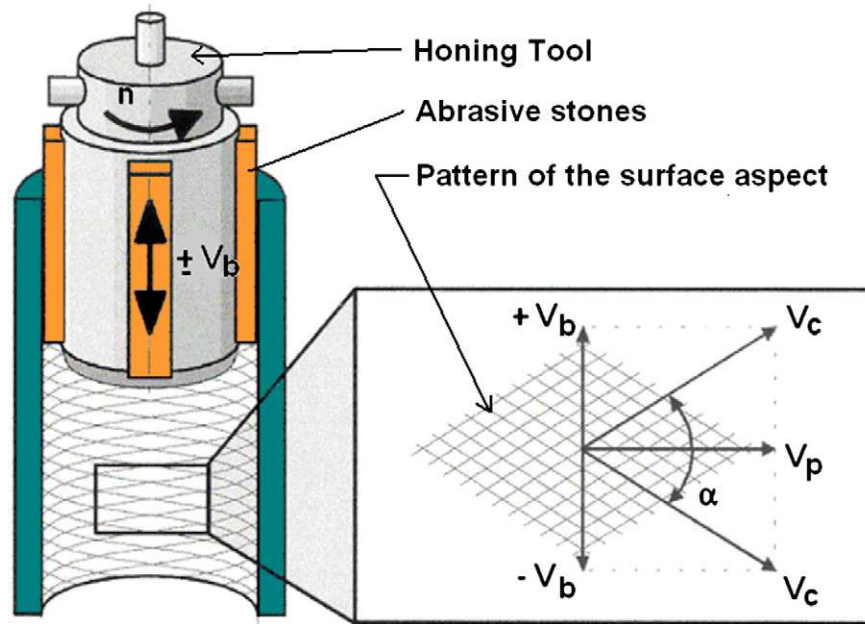

Fig. 1. Honing kinematics and surface aspect.

the texture quality of the surfaces obtained. In theory, high acceleration is recommended to reduce the variability of the groove angle in the larger zone of the stroke motion. Actually, while acceleration is lower, some curved grooves are created on the top and the bottom of the cylinder. Besides, in mass production, this acceleration is fixed at 1.5 g. This choice enables manufacturers to achieve the desired quality without wearing out the machine unnecessarily.

2. Experiment details

This experimental research involves the honing of 18 engine cylinder blocks (Renault K9K, 1.5 dCi), namely, 72 cylinders with diameter of 76,005 mm and height of 140 mm. For this type of engine, the honing process is achieved by three successive stages: a rough honing stage, a finishing stage and a plateau stage. The rough honing stage is carried out with an 8-stone honing tool having diamond metal bonded abrasive stones to reduce the length of the cycle [6]. Its goal is to reduce the form defects of the cylinder bore.

The finishing and plateau stages are carried out with a double expansion honing tool.

The second stage, finish honing, activates an expansion with 6 abrasive stones of Silicon Carbide. Its role is to reduce the roughness and to create a suitable texture [7].

The third stage, plateau honing stage, uses 4 abrasive stones with a low grit size to smooth down the surface and obtain a plateaued surface appearance [2].

During the honing stages, the cylinder bore, which undergoes intensive cutting pressure, is deformed. As the geometry of the carter is not entirely symmetrical, each cylinder bore is deformed differently from the others [8]. Consequently, direct comparison of the form defects between the four barrels of an engine is not possible. Each set of measurements is carried out on the same cylinder bore on at least 6 cylinder blocks. The honing machine “Gehring” allows the hydraulically control of the alternate inversion acceleration for each stage of the honing process. Optimal cutting conditions were chosen for each stage [9,10]. The process parameters are summarized in Table 1. All parameters are unmodified in relation to their initial values, excluding acceleration.

Firstly, the cylindrical form error obtained after the rough honing stage on cylinder no. 3 and no. 4 will be examined.

Subsequently, the roughness obtained after the finishing stage is studied on the cylinder no. 2.

Finally, the impact of the dynamics on the surface appearance of surfaces obtained after the plateau honing stage on cylinder no. 1 will be investigated with the 3D multiscale analysis [11].

3. Result and discussion

3.1. Impact on the cylindrical form error

The quality of the rough honing depends on the form defects of the finished cylindrical surface. It is a common practice to verify the form defect criteria according to their description in the norm [12] with a shape measurement machine (Mahr). Circularity defects on the three levels of the cylinder as well as four defects of straightness at the 0°, 90°, 180°, and 270° angles are calculated based on points measured through contact probe and then filtered with a Gaussian filter 0-50. These measurements also allow calculating the barrel cylindricality defect.

Table 1
Experimental honing process setup.

		Honing stage		
		1) Rough	2) Finish	3) Plateau
Abrasive and honing tool parameters	Abrasive type	Diamond metal bonded	Silicon carbide	Silicon carbide
	Grit size	120 μm	80 μm	40 μm
	Stone number	8	6	4
	Stone size [mm]	3×70	6×70	6×70
Stroke and rotation parameters	Cutting speed V_c	60 m/min	50 m/min	50 m/min
	Honing Angle α	45°	45°	45°
	Stroke speed V_b	23 m/min	19 m/min	19 m/min
	Rotation speed	235 rpm	196 rpm	196 rpm
	Alternate inversion acceleration [g]	0.5, 1.0, 1.5, 2.0, 2.5	0.5, 1.0, 1.5	0.5, 1.0, 1.5
	Radial speed	6 μm/s	4 μm/s	–
Expansion parameters	Honing force	–	–	6 MPa
Experiment	Honed cylinder	no. 1, no. 2, no. 3, no. 4	no. 1, no. 2	no. 1

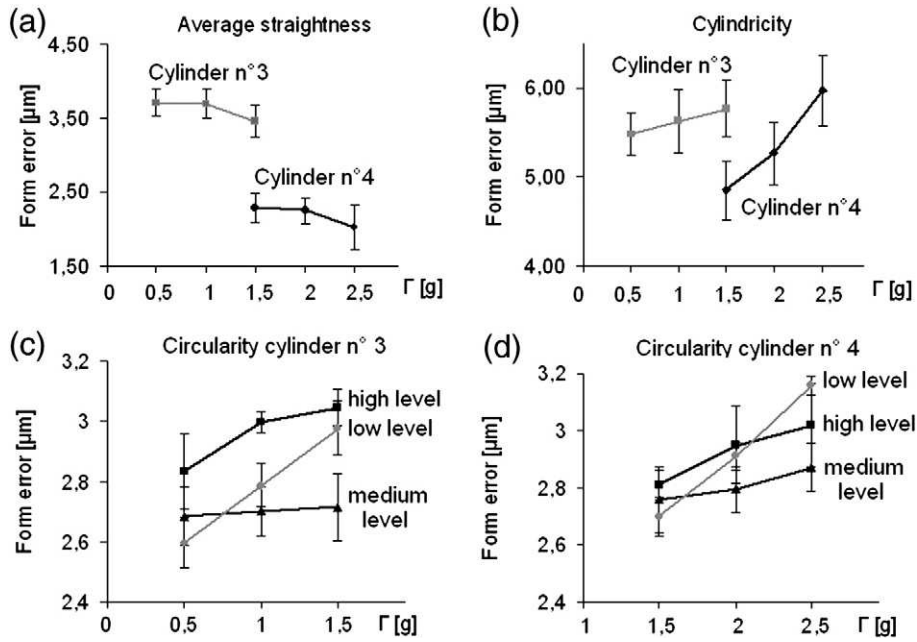

Fig. 2. Form defects after rough honing.

Before the rough honing process, the average default straightness was $4.50 \pm 0.12 \mu\text{m}$ for cylinder no. 3 and $2.90 \pm 0.13 \mu\text{m}$ for cylinder no. 4. The initial default cylindricity was $14.80 \pm 2 \mu\text{m}$ for cylinder no. 3 and $13.6 \pm 2.5 \mu\text{m}$ for cylinder no. 4. The average of three defaults circularity was $8.3 \pm 2.2 \mu\text{m}$ for cylinder no. 3 and $7.3 \pm 2.3 \mu\text{m}$ for cylinder no. 4.

Form defects on cylinders after rough honing can be observed on cylinder bore no. 3, honed at an acceleration of 0.5 to 1.5 g and on cylinder bore no. 4 at an acceleration of 1.5 to 2.5 g. The rough honing stage is finished when the correct diameter is reached, after approximately 40 strokes, namely, after 30 s at acceleration of 2.5 g and after 36 s at an acceleration of 0.5 g. Form defects prior to honing are almost identical for all the samples. Thus, cylindricity defect is equal to $15.3 \pm 1.6 \mu\text{m}$ for cylinder bore no. 3 and $12.5 \pm 2.1 \mu\text{m}$ for cylinder bore no. 4. Average straightness defects prior to honing correspond to

$4.15 \pm 0.6 \mu\text{m}$ and $2.08 \pm 0.35 \mu\text{m}$. On the rough honing stage, the entire number of form defects decreased and the difference between the cylinder bores no. 3 and no. 4 were slightly less visible. Fig. 2(a) illustrates the cylindricity defects. These defects increase on acceleration. This phenomenon is particularly visible when the acceleration goes beyond 2 g.

The four straightness defects measured were weighted and are illustrated in Fig. 2(b). However, it has been observed that the straightness defect decreases when the honing is carried out at high stroke acceleration.

Circularity defects in Fig. 2(c) and (d) will now be examined. Observations show that the increase in the inversion acceleration is associated to a significant deterioration of circularity at level 1 (high). This result is even worse at level 3 (low). This phenomenon is not particularly visible at level 2, on the middle of the cylinder liner.

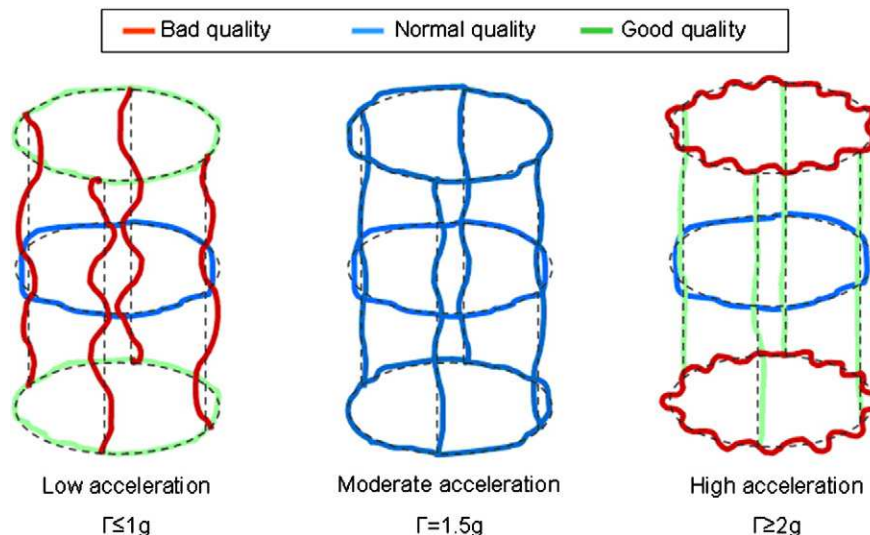

Fig. 3. Impact of dynamics on form defect criteria.

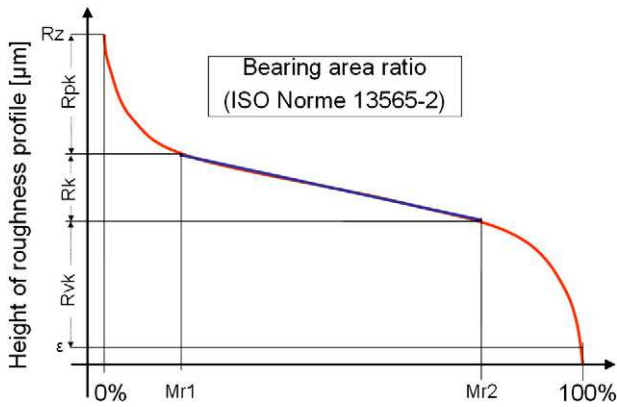

Fig. 4. Roughness criterion based on bearing area ratio.

This can be explained by the fact that, as the middle zone is honed at a constant stroke speed, variations in acceleration do not modify the trajectory in this zone.

These observations enable us to confirm that the inversion acceleration of the stroke motion and therefore, the stroke trajectory

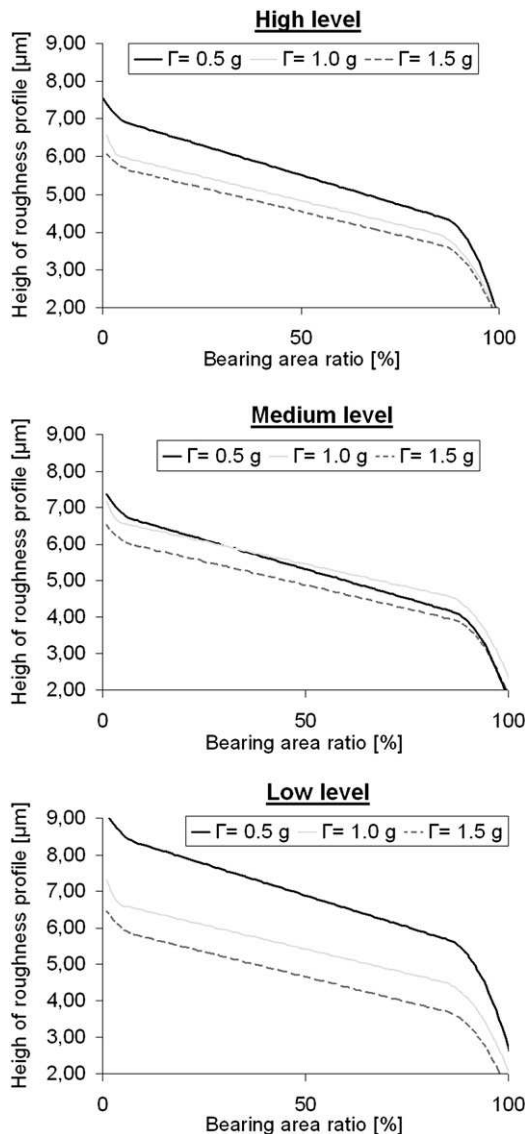

Fig. 5. The progression of bearing area ratio according to acceleration.

play an important role in form quality. The slower the acceleration, the longer the duration of inversion Δt at the high and low points will be. However, when the inversion acceleration is high, the axial speed is lowered for a shorter period, producing a better quality of straightness.

Finally, Fig. 3 summarizes these observations: the cylindricity defect is not affected strongly as it depends on the circularity and the straightness levels, which are balanced for each test.

3.2. Impact on the micro-geometry obtained

Micro geometry is verified by analyzing the roughness profile following the axial direction of the cylinder bore on its side at 3 levels high, medium and low. The values of the Rz, Rpk, Rk, Rvk, Mr1 and Mr2 criteria were obtained following analysis of the bearing area ratios of the profile, measured according to the norm ISO13565-2:96 [13] using a Perthen machine.

These parameters are defined as following:

- Rk: core roughness depth: depth of the roughness core profile.
- Rpk: reduced peak height: average height of protruding peaks above roughness core profile.
- Rvk: reduced valleys depth: average depth of valleys projecting through roughness core profile.
- Mr1: material portion 1: level in %, determined for the intersection line which separates the protruding peaks from the roughness core profile.
- Mr2: material portion 2: level in %, determined for the intersection line which separates the deep valleys from the roughness core profile.

A probe with a $2 \mu\text{m}$ tip radius is used to record the roughness profile over a length of 16.8 mm. Fig. 4 illustrates the bearing area ratio curves remodeled according to the aforementioned criteria.

Fig. 5 shows the bearing area ratio curve for different acceleration whereas, Table 2 represents average roughness criterion values for different levels. It can be seen from Fig. 5 that the inversion dynamics of the stroke motion has an impact on roughness at the low and high levels because the honing time Δt in these areas increases when the acceleration decreases. This phenomenon is more visible at the low level. This leads to an increase of 11% of the Rz when the acceleration decreases from 1.5 to 1 g, and an increase of 20% from 1 to 1.5 g.

As foreseen, the variations in roughness are much less visible in the middle. However, the increase of 12% in roughness for accelerations of 0.5 g and 1 g in comparison with 1.5 g can be interpreted by the poor regeneration of the abrasive stone. As a result of these experiments, the following conclusion can be drawn: the decrease in acceleration leads to a degradation of the roughness. One can also add that the stroke dynamics play a role in the regeneration of the stone, which guarantees the constant quality of the process in terms of micro-geometry.

3.3. Impact on the texture obtained

The surface aspect sought in honing is a texture of crosshatched grooves at the honing angle (45°) which guarantee oil retention for the adequate lubrication of piston segments [4]. Low inversion acceleration of the stroke motion leads to traces of horizontal grooves with α close to zero at the base and top of the cylinder liner. In order to study the quality of the texture obtained through honing, the method developed by Sabri et al. [11], was implemented. The frequential breakdown of the surface topography in 3D leads to the identification of four digital criteria: the cross angle of the groove, the angle of the grooves (left or right), the groove density and the m-turn criterion.

Table 2
Roughness criteria measures.

	High level			Medium level			Low level		
	$\Gamma=0.5$ g	$\Gamma=1.0$ g	$\Gamma=1.5$ g	$\Gamma=0.5$ g	$\Gamma=1.0$ g	$\Gamma=1.5$ g	$\Gamma=0.5$ g	$\Gamma=1.0$ g	$\Gamma=1.5$ g
Rpk	0.70 ± 0.04	0.58 ± 0.02	0.45 ± 0.09	0.71 ± 0.06	0.63 ± 0.04	0.55 ± 0.03	0.82 ± 0.09	0.69 ± 0.02	0.66 ± 0.04
Rk	2.50 ± 0.10	2.02 ± 0.11	1.95 ± 0.18	2.51 ± 0.05	1.98 ± 0.08	2.03 ± 0.17	2.66 ± 0.07	2.09 ± 0.05	2.11 ± 0.10
Rvk	1.82 ± 0.11	1.67 ± 0.10	1.55 ± 0.11	1.83 ± 0.14	1.71 ± 0.17	1.59 ± 0.12	2.21 ± 0.23	1.81 ± 0.13	1.60 ± 0.20
Rz	7.57 ± 0.35	6.57 ± 0.36	6.06 ± 0.47	7.37 ± 0.34	7.20 ± 0.66	6.52 ± 0.34	9.14 ± 0.71	7.30 ± 0.46	6.47 ± 0.50
Mr1	7.00 ± 0.34	3.61 ± 0.30	6.93 ± 0.30	6.88 ± 0.51	3.81 ± 0.37	6.70 ± 0.44	7.48 ± 0.32	4.13 ± 0.17	7.00 ± 0.34
Mr2	86.3 ± 0.27	82.8 ± 0.67	84.3 ± 0.75	85.3 ± 0.71	83.9 ± 0.64	85.1 ± 0.66	84.3 ± 0.80	82.9 ± 0.58	84.0 ± 0.66

The “m-turn” parameter is developed by Sabri et al. [11] to detect the presence of residual turning grooves. It is defined by the following expression:

$$m_{turn} = \frac{\sum_{f \in A} \psi_{ss}(f)}{\sum_{f \in A_{\perp}} \psi_{ss}(f)}. \quad (5)$$

The sets A and A_{\perp} are defined according to Fig. 6 as wedges centered around the x - and y -axis, respectively, with an angle of 10° .

In Eq. (5), $\psi_{ss}(f)$ represents the amplitude of the surface PSD (Power Spectrum Density) local maxima by this equation:

$$PSD(S) = |FFT(S(x,y))|^2 \quad (6)$$

where S is the honed surface topography, N and M represents the sizes in x and y directions respectively (Fig. 6).

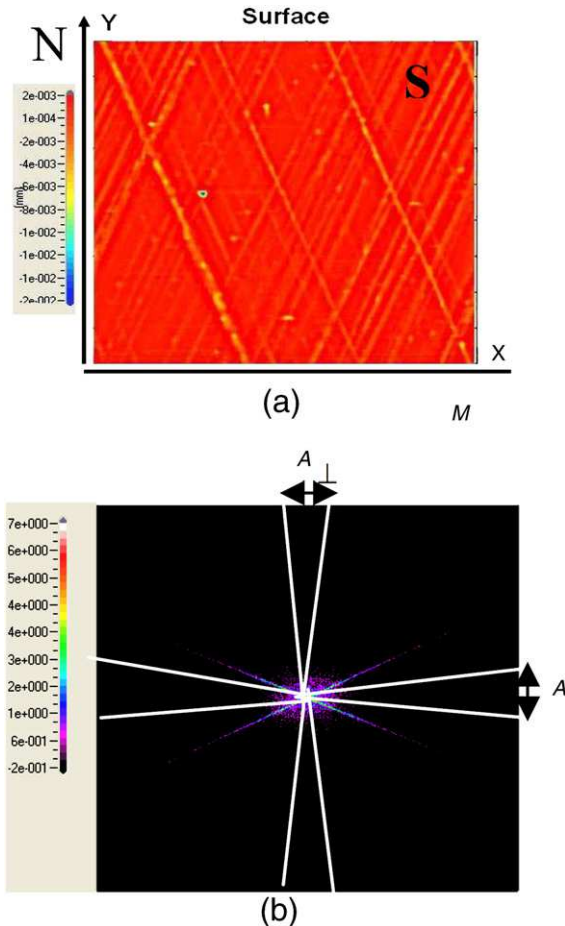

Fig. 6. (a) Honed surface, (b) the frequency representation of the surface [11].

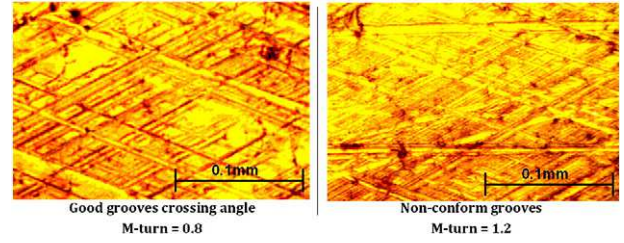

Fig. 7. Optical micrographs of the surface grooves and m-turn criteria [11].

The $m_{turn} \geq 1$ values indicate an unwanted process state that turning grooves are present. It also detects the emergence of stray grooves with directions similar to those of typical turning grooves. This case is observed frequently at the Top Dead Center caused by the downtime of the machine.

This last element enables us to quantify badly positioned grooves, namely grooves at angles other than those intended. Texture related to a groove angle of 45° corresponds to an m-turn criterion under 1.00. In Fig. 7, we see two aspects of honed surface. One has a good surface with an m-turn value of 0.8 m. The other is badly honed because there are lots of horizontal grooves.

Analysis of the traces on the honed surfaces at three levels of the barrel on samples of 0.8×0.8 mm was carried out under a white-light interferometric microscope. The result averages of the measurements of the 18 cylinders produced after the finish honing stages are shown in Fig. 8. Only an acceleration of 1.5 g allows conformity on all three levels to be reached.

As foreseen, if the acceleration weakens, Δt and Δz increase, leading to a deterioration of the quality of the texture on the edges. When the acceleration slows down, the quality of the middle segment is slightly deteriorated. This phenomenon can be explained by the highest level of roughness due to a lower quality regeneration of the abrasive stones.

4. Conclusion

To sum up, inversion stroke dynamics affect the three quality scales of the honed cylinders. Cylindricity is not greatly affected but weak

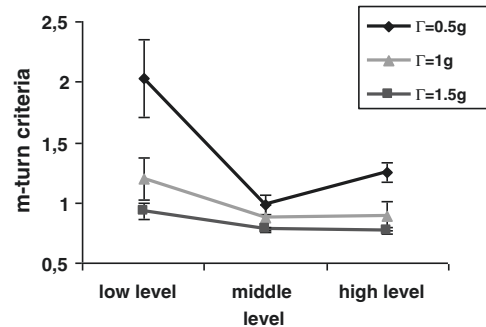

Fig. 8. Surface aspects at 3 levels and 3 acceleration speeds [11].

acceleration improves roundness quality, and strong acceleration improves straightness quality. The quality of the micro-geometry and the aspect of surfaces scanned during the stroke inversion are decreased when acceleration is reduced. Inversion dynamics seem to play a role in the regeneration of abrasive stones since the roughness and surface aspects are deteriorated in the middle of the barrel, where the trajectory of the stones follows the established groove angle. The impact of dynamics on the regeneration of the abrasive during honing will be examined in future experiments where the erosion of the stones after several hours of honing will be analyzed.

References

- [1] G. Haasis, U.-P. Weigmann, *Ind. Diam. Rev.* 59 (582) (1999) 205.
- [2] B. Muralikrishnan, J. Raja, *J. Manuf. Sci. Eng.* 127 (2005) 193.
- [3] L. Sabri, S. Mezghani, M. El Mansori, H. Zahouani, *Wear* 271 (3-4) (2011) 509.

- [4] J. Lee, S. Malkin, *J. Eng. Ind. Trans. ASME* 115 (4) (1993) 406.
- [5] T. Sasaki, K. Okamura, *Jpn. Soc. Mech. Eng.* 2 (5) (1959).
- [6] H. Weule, M. Eversheim, *CIRP Ann. Manuf. Technol.* 37 (1) (1988) 339.
- [7] D. Bardac, I.D. Marinescu, in: *Surface Generation in the Case of Honing with Superabrasives*, Society of Manufacturing Engineers, 1999, p. 1, (Issue MR99-240).
- [8] P. Covington, L. Sabri, J.V. Le Lan, in: *12th CIRP conference on Modelling of Machining Opérations*, Donostia-San-Sebastien, Espagne, 2009, (7-8 Mai).
- [9] L. Sabri, S. Mezghani, M. El Mansori, *Surf. Coat. Technol.* 205 (2010) 1515.
- [10] L. Sabri, M. El Mansori, *Surf. Coat. Technol.* 204 (6-7) (2009) 1046.
- [11] L. Sabri, S. Mezghani, M. El Mansori, J.-V.L. Lan, *Trans. North Am. Manuf. Res. Inst. SME* 37 (2009) 661.
- [12] International Organization for Standardization, Geneva, Switzerland, ISO 1101, *Geometrical Product Specifications (GPS) – tolerances of form, orientation, location and run out*, International Standard ISO, 2004.
- [13] International Organization for Standardization, Geneva, Switzerland, ISO 13565-2, *Surface texture: profile method, surfaces having stratified functional properties*, International Standard ISO, 1996.