



HAL
open science

Optimal control of variable speed wind turbines

Andreea Pinteá, Nicolai Christov, Pierre Borne, Dumitru Popescu, A. Badea

► **To cite this version:**

Andreea Pinteá, Nicolai Christov, Pierre Borne, Dumitru Popescu, A. Badea. Optimal control of variable speed wind turbines. The 19th Mediterranean Conference on Control and Automation June, Aquis Corfu Holiday Palace, Corfu, Greece., Jun 2011, Corfu, Greece. hal-00719468

HAL Id: hal-00719468

<https://hal.science/hal-00719468>

Submitted on 19 Jul 2012

HAL is a multi-disciplinary open access archive for the deposit and dissemination of scientific research documents, whether they are published or not. The documents may come from teaching and research institutions in France or abroad, or from public or private research centers.

L'archive ouverte pluridisciplinaire **HAL**, est destinée au dépôt et à la diffusion de documents scientifiques de niveau recherche, publiés ou non, émanant des établissements d'enseignement et de recherche français ou étrangers, des laboratoires publics ou privés.

Optimal control of variable speed wind turbines

Andreea Pinteaa, Nicolai Christov, Pierre Borne, Dumitru Popescu, Adrian Badea

Abstract—this paper proposes a MIMO linear quadratic regulator (LQR) controller designed for a horizontal variable speed wind turbine with focus on the operating range referring to the above rated wind speeds. The operating conditions of wind turbines make them subject to fluctuating loads that create fatigue and lead to damage. Alleviating these loads would reduce the needed materials, and increase the lifespan and the quality of the produced energy. The optimality of the entire system is defined in relation with the trade-off between the wind energy conversion maximization and the minimization of the fatigue in the mechanical structure. The solution of a control using an LQR regulator is presented. The performances of the optimal control are assessed and discussed by means of a set of simulations.

I. INTRODUCTION

Classical control system design is generally a trial and error process in which various methods of analysis are iteratively used to determine the design parameters of a system. Acceptable performance is generally defined in terms of time and frequency domain criteria such as rise time, settling time, overshoot, gain and phase margin and bandwidth.

Radically different performance criteria must be satisfied, however, by the complex, multiple inputs, and multiple outputs systems required to meet the demands of modern technology.

The objective of optimal control theory is to determine the control signals that will cause a process to satisfy the physical constraints and at the same time to minimize or maximize some performance criterion. [1]

The wind industry offers many challenges in designing effective wind turbines that will harness wind energy and will transform it into electricity. Wind turbines are large, complex dynamically flexible structures that operate in turbulent and unpredictable environmental conditions where efficiency and reliability are highly dependent upon a well designed control strategy.

From a control point of view, the importance lies not only

on ensuring an optimal operation, but also on load reduction and grid integration. Another important challenge is to provide good quality energy delivery from a profoundly irregular primary source, the wind.

The characteristics of the wind energy source are important in different aspects regarding wind energy exploitation. The energy available in the wind varies with the cube of the wind speed. The wind is variable both in space and in time [2].

Based on the value of the wind speed, there were two essential functioning regimes identified for the wind turbines. The first one corresponds to low wind operation, and here the main control goal is to maximize the energy capture.

This region ends when the wind's speed reaches the "rated value", above which, the turbine enters the second regime. This value is usually around 14m/s.

In the above rated region, the pitch angle and the electromagnetic torque are the control variables that are used to reduce the structural loads and to maintain the output power around a constant nominal value, also called the rated power of the turbine (Fig. 1).

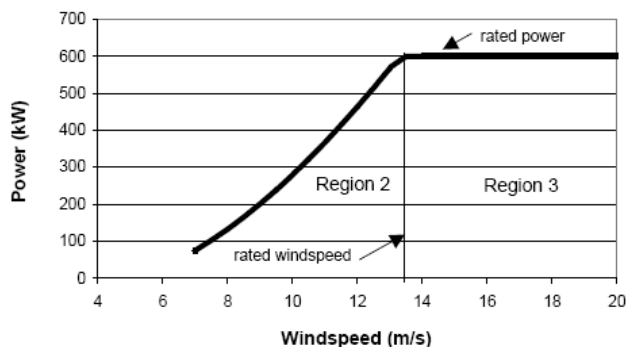

Fig.1 Typical wind turbine power curve

Therefore, in this regime, the system is multivariable and multi-objective. Many applications used classical controls to address more than one control objective, by adding multiple control loops.

These added complexity to the control design and system's behavior but, nevertheless, it was difficult to properly address control-structure interaction issues because the controller used only a single measured turbine output as the basis of its control and did not have direct knowledge of the dynamics of the turbine. Modern control designs using state space methods, can handle these issues in a better way, since the controllers in these cases use a model to determine the system's states. Controllers can be designed not only to

Manuscript received January 30, 2011.

A. P. Author is with the University "Politehnica" Of Bucharest, Romania (corresponding author, e-mail: andreea.pinteaa@gmail.com).

N. C. Author is with Universite Lille 1, Lille, France, LAGIS Department (e-mail: Nicolai.Christov@univ-lille1.fr).

P. B. Author is with Ecole Centrale de Lille, France, LAGIS Department (e-mail: Pierre.borne@ec-lille.fr)

D. P. Author is with the University "Politehnica" of Bucharest, Romania, (e-mail: popescu_upb@yahoo.com)

A. B. Author is with the University "Politehnica" of Bucharest, Romania, (e-mail: badea@energ.pub.ro)

maximize power or to regulate the turbine's speed, but also to add damping to its flexible modes, through state feedback [3]. In the same context, the LQR regulator, proved to be a good solution due to the fact that it facilitates multivariable and multi-objective control design.

The paper is organized as follows: after a short introduction and the presentation of the context in which the LQR controller was chosen, one continues with Section II in which the mathematical model of the turbine is presented in detail. Section III provides a description of the LQR control method and Section IV presents the analysis of the results and the concluding remarks of this study. In the end of the paper, an APPENDIX with the numerical values of the wind turbine's parameters used is provided.

II. MATHEMATICAL MODEL

At present, there are several variable speed wind turbine configurations that are being widely used. For this study, a horizontal variable speed wind turbine was chosen. The variable speed wind turbine is currently the most used technology and it has proven its advantages over the years [4]. The major advantage is that by allowing the rotor to operate at various speeds, one can obtain a more efficient capture of the wind energy with less stress in the turbine drive train during wind gusts. The reader can find different wind turbine modeling techniques in [2] and also detailed explanations regarding the use of each type of model.

Generally, a model for an entire wind energy conversion system can be structured as several interconnected subsystem models: an aerodynamic, a mechanical, electrical and actuator subsystems. But since the dominant dynamics lie in the mechanical subsystem, special attention will be paid in this direction. The mechanical structure that we chose to study is seen as being arranged into several rigid bodies linked by flexible joints. The amount of these joints or degrees of freedom, determines the order of the model.

In [5] [6] and [3] one can observe the way in which the number of degrees of freedom of the system can increase the order of the non linear models of the turbine. Therefore, it is important to consider on the model just those degrees of freedom that are directly coupled to the control [4].

By this reason, the model presented here, will include just the first mode of the drive train, the first mode of tower bending dynamics, and the first mode of the flapping of the blades. These degrees of freedom will suffice for the controller design that will be presented (Fig. 2). The drive train is modeled as a two rigid bodies linked by a flexible shaft (Fig. 3). Also it was supposed that the two blades move in unison and support the same forces.

In order to compute the model, we have started from a theory that states that a mechanical system of arbitrary complexity can be described by the equation of motion:

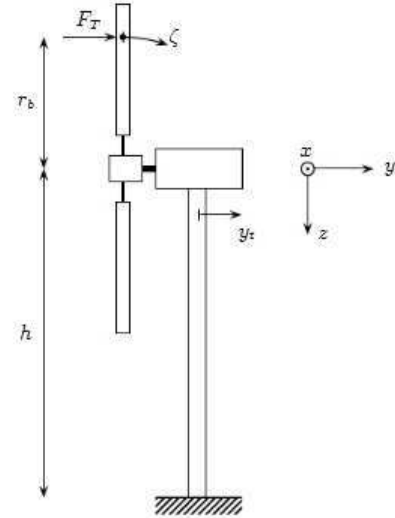

Fig. 2 The mechanical structure of the wind turbine

$$M \cdot \ddot{q} + C \cdot \dot{q} + K \cdot q = Q(\dot{q}, q, t, u) \quad (1)$$

where M , C and K , are the mass, damping and the stiffness matrices, Q is the vector of forces acting on the system, and q_i is the generalized coordinate. For our model, the generalized coordinates are: $q = (\omega_T, \omega_G, \zeta_1, \zeta_2, y_T)$, where ω_T is the angular speed of the rotor, ω_G stands for the angular speed of the generator, ζ_1 and ζ_2 are the flaps of the blades, while y_T represents the horizontal movement of the tower (Fig. 2).

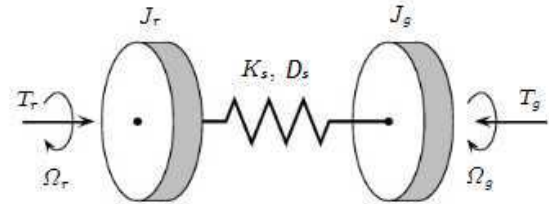

Fig. 3 The two mass model representation of the drive train

Since the thrust forces acting on the blades are equal, it is naturally to consider $\zeta_1 = \zeta_2 = \zeta$ and $F_{aero1} = F_{aero2} = F_{aero}$, which transforms q into $q = (\omega_T, \omega_G, \zeta, y_T)$. In the same time, one can find Q as being:

$$Q = (C_{aero}, -C_{em}, F_{aero}, 2 \cdot F_{aero}) \quad (2)$$

The considered forces that are acting on the system are: C_{aero} , the aerodynamic torque, C_{em} , the electromagnetic torque, and F_{aero} , representing the thrust. The aerodynamic torque and the force acting on the entire rotor are expressed in terms of non-dimensional power coefficient C_p and thrust coefficient C_T respectively, as follows

$$C_{aero} = \frac{1}{2} \cdot \rho \cdot \pi \cdot R^2 \cdot C_p(\lambda, \beta) \cdot \frac{v^3}{\omega_T}$$

$$F_{aero} = \frac{1}{2} \cdot \rho \cdot \pi \cdot R^2 \cdot C_T(\lambda, \beta) \cdot v^2 \quad (3)$$

where ρ represents the air density, R is the blade radius, and

v is the average speed of the wind.

The power coefficient is one of the most important parameters of the wind turbine because it offers information upon the efficiency of the turbine, it helps defining the control objectives in the below rated regime and also it characterizes the aerodynamic torque that moves the turbine's rotor. The power and the thrust coefficients can be expressed in a polynomial form, and depend on two parameters which are the tip speed ratio λ and the pitch angle β of the blades.

In order to derive the mathematical model, one has used the Lagrange equation that offers a systematic procedure to calculate such models

$$\frac{d}{dt} \left(\frac{\partial E_c}{\partial \dot{q}_i} \right) - \frac{\partial E_c}{\partial q_i} + \frac{\partial E_d}{\partial \dot{q}_i} + \frac{\partial E_p}{\partial q_i} = Q \quad (4)$$

Here, E_c , E_d , and E_p denote the kinetic, dissipated and potential energies. After a few calculations, applied for our system, one obtains

$$\begin{aligned} E_c &= \frac{J_T}{2} \cdot \omega_T^2 + \frac{J_G}{2} \cdot \omega_G^2 + \frac{M_T}{2} \cdot \dot{y}_T^2 + M_P \cdot (\dot{y}_T + r_p \cdot \dot{\zeta})^2 \\ E_d &= \frac{d_A}{2} \cdot (\omega_T - \omega_G)^2 + d_p \cdot (r_p \cdot \dot{\zeta})^2 + \frac{d_T}{2} \cdot \dot{y}_T^2 \\ E_p &= \frac{k_A}{2} \cdot (\theta_T - \theta_G)^2 + k_p \cdot (r_p \cdot \zeta)^2 + \frac{k_T}{2} \cdot y_T^2 \end{aligned} \quad (5)$$

These energies were calculated under the supposition that the generalized force that acts on the rotor is applied on a point situated at the distance r_p on each blade from the hub of the rotor (Fig. 2). In the above equations, J_T and J_G represent the rotor and the generator moments of inertia, M_T and M_P are the masses of the tower and of the blade, d_p , d_A and d_T represent the damping coefficients for the blade, drive shaft and tower. Similarly, k_p , k_A and k_T stand for the spring coefficients of the blade, drive shaft and tower. θ_T and θ_G are the angular positions of the rotor and generator.

The interconnection of the models of different plant subsystems, leads to a global highly non linear system, mainly because of the expressions of the aerodynamic torque and of the thrust force, both given in (3).

For control design purposes, we linearized the model around an operating point S_{op}

$$C_{aero} = D_{c\omega} \cdot \omega_T + D_{c\beta} \cdot \beta + D_{cv} \cdot v \quad (7)$$

$$F_{aero} = D_{f\omega} \cdot \omega_T + D_{f\beta} \cdot \beta + D_{fv} \cdot v$$

Here

$$D_{c\omega} = \left(\frac{\partial C_{aero}}{\partial \omega_T} \right)_{Sop}, D_{c\beta} = \left(\frac{\partial C_{aero}}{\partial \beta} \right)_{Sop}, D_{cv} = \left(\frac{\partial C_{aero}}{\partial v} \right)_{Sop}$$

$$\text{,and} \quad D_{f\omega} = \left(\frac{\partial F_{aero}}{\partial \omega_T} \right)_{Sop}, \quad D_{f\beta} = \left(\frac{\partial F_{aero}}{\partial \beta} \right)_{Sop},$$

$$D_{fv} = \left(\frac{\partial F_{aero}}{\partial v} \right)_{Sop} \text{ respectively.}$$

Besides these equations, in order to interconnect the models of the individual subsystems, one must include into

the model, the pitch controller. This was modeled here as a first degree order system [7]:

$$\frac{\beta}{\beta_{ref}} = \frac{1}{1 + T_\beta \cdot s}, \text{ where } \beta_{ref} \text{ is the desired pitch angle}$$

and β is the actual pitch angle of the blades.

We have taken into consideration the fact that the pitch servomotor has some physical limitations, and we have modeled them by including into our model one saturation in the position and one in the speed. For this study we have supposed that the saturation values in position are -45° and 45° , and that the servomotor does not exceed the speed of $10^\circ /s$. In Fig. 4 one can observe the way the pitch servomotor's dynamics were modeled.

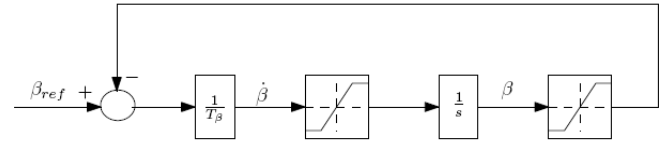

Fig. 4 The pitch servomotor dynamics modeling

After combining all these equations, one can put (4) into the classical state-space representation

$$\dot{x}(t) = A \cdot x(t) + B \cdot u(t) + E \cdot m_v \quad (8)$$

$$y(t) = C \cdot x(t) + D \cdot u(t)$$

in which m_v represents a perturbation acting on the system, and from a physical point of view it models the eventual wind gusts that appear.

$$A = \begin{pmatrix} 0 & 0 & 0 & 1 & -1 & 0 & 0 & 0 & 0 \\ 0 & 0 & 0 & 0 & 0 & 1 & 0 & 0 & 0 \\ 0 & 0 & 0 & 0 & 0 & 0 & 1 & 0 & 0 \\ -51.4 & 0 & 0 & -0.69 & 0.28 & 0 & 0 & -2 & 0.04 \\ 268.29 & 0 & 0 & 1.46 & -1.46 & 0 & 0 & 0 & 0 \\ 0 & -390.47 & 30.35 & 0.15 & 0 & -3.9 & 0.17 & -0.13 & 0.04 \\ 0 & 457.14 & -242.85 & -0.21 & 0 & 4.57 & -1.42 & -0.21 & 0.07 \\ 0 & 0 & 0 & 0 & 0 & 0 & 0 & -5.55 & 0 \\ 0 & 0 & 0 & 0 & 0 & 0 & 0 & 0 & -0.14 \end{pmatrix}$$

$$B = \begin{pmatrix} 0 & 0 & 0 & 0 & 0 & 0 & 0 & 1 \\ 0 & 0 & 0 & 0 & -2.44 \cdot 10^{-5} & 0 & 0 & 0 \\ 0 & 0 & 0 & 0 & 0 & 0 & 5.55 & 0 \end{pmatrix}^T$$

$$C = \begin{pmatrix} 0 & 0 & 0 & 1 & 0 & 0 & 0 & 0 & 0 \\ 0 & 0 & 0 & 0 & 0.25 & 0 & 0 & 0 & 0 \\ 0 & 0 & 1 & 0 & 0 & 0 & 0 & 0 & 0 \\ 0 & 1 & 0 & 0 & 0 & 0 & 0 & 0 & 0 \end{pmatrix}, \quad D = \begin{pmatrix} 0 & 0 & 10^{-5} \\ 0 & 0 & 0 \\ 0 & 0 & 0 \\ 0 & 0 & 0 \end{pmatrix}$$

$$E = (0 \ 0 \ 0 \ 0 \ 0 \ 0 \ 0 \ 0 \ 1)$$

The system is multivariable; there have been identified three inputs and four outputs (Fig. 5). As shown in this control scheme, the input variables of the system are considered: v_m the average value of the wind speed, and the two control variables: the pitch angle, β , and the electromagnetic torque C_{em} .

Here, we have considered the state vector $x^T = (\theta_T - \theta_G, \zeta, y_T, \omega_T, \omega_G, \dot{\zeta}, y_T, \beta, v)^T$, the output of the system $y = (P_{el}, \omega_T, \zeta, y_T)$, and the command signal $u = (\beta, C_{em})$. The first component of the output vector represents the electrical power generated by the turbine. It can be

computed as $P_{el} = \omega_G \cdot C_{em}$ but in this paper, its normalized value was used.

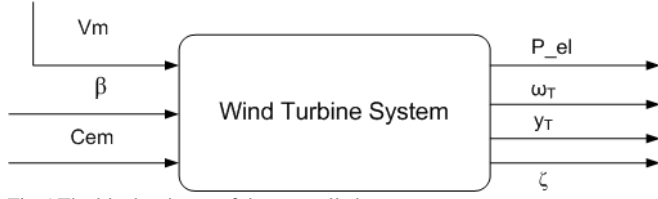

Fig.5 The block scheme of the controlled system

The other output variables that we are interested in are ω_T because the goal is to try to maintain it constant to its nominal value, no matter the changes that appear in the environment, the flap mode of the blades ζ and of the tower y_T respectively, because, it is desired that these variables be as much as possible.

The two available control variables are the pitch angle and the electromagnetic torque. The numeric values of the wind turbine's parameters can be found in the APPENDIX, at the end of the paper.

III. GENERAL PROCEDURE OF THE LINEAR QUADRATIC CONTROLLER DESIGN

As previously said, there is a large variety of control techniques that were applied to wind turbines in a permanent attempt to improve their functioning and to benefit as much as possible from the energy that they can produce. In literature, one can find proposed solutions for mono-variable systems as well as for multi-variable ones.

In [8], for instance, one can find a compared study made upon the simulation results obtained with three controllers: a classical PID regulator, a full state feedback and a fuzzy controller. The author's conclusion is that the PID controller ensures good performances with power regulation but not with reducing the structure's mechanical loads. In the same time, the full-state feedback controller manages to reduce these loads even under turbulent conditions.

The idea of conveniently sizing a trade-off between energy efficiency and increasing the lifetime of the wind turbines by alleviating fatigue loads is continuously being paid special attention, even when employing controllers like PI or PID. However, these approaches do not allow a rigorous control design in order to perform a fine tuning of the trade-off between the energy performance and the reliability demands [9].

These aspects, together with its design simplicity and the advantages it could bring, lead us to the idea of choosing a state feedback linear quadratic controller (LQR) for this study.

For its design, one imposes a quadratic cost function defined as

$$J = \int_0^{\infty} (y^T \cdot Q \cdot y + u^T \cdot R \cdot u) \cdot dt \quad (9)$$

The feedback control law that minimizes the value of this

cost is given by:

$$u = -K \cdot x + K_r \cdot r,$$

where K is given by $K = R^{-1} \cdot B^T \cdot P_c$, P_c is given by the solution to the equation:

$$P_c \cdot A + A^T \cdot P_c - P_c \cdot B \cdot R^{-1} \cdot B^T \cdot P_c + Q = 0 \quad (10)$$

while K_r is being defined by:

$$K_r = -(R_1)^{-1} \cdot B^T \cdot ((A - B \cdot K)^T)^{-1} \cdot C^T \cdot Q \quad (11)$$

This matrix ensures the reference input is scaled in order to become equal to the feedback signal provided by the LQR regulator. This algorithm guaranties that no matter, any two symmetric and positive definite matrixes Q and R that we chose in order to minimize the quadratic criteria, there is always a matrix P_c , also symmetric and positive definite, that represents the solution of the Ricatti equation (10).

Through this criterion, by replacing the variables y and u by the corresponding vectors presented in Section 2, one tries to minimize the flap mode of the blades and the tower oscillation respectively, maintain the electrical power level and the angular speed of the rotor at the desired levels while computing the appropriate command.

The typical rule for choosing the weighting matrixes R and Q is the Bryson's rule, which states that these matrixes should be selected as diagonal with the non-zero elements scaled so that the variables that appear in the optimization criterion have a maximum value of one [10] [11] [12].

This is important especially for the situations when the units used for the different components of the command and state vectors are numerically very different from each other. This is also our case, in the command vector, for instance, the pitch angle and the electromagnetic torque have different order of degree units.

Although Bryson's rule gives good results, often it is just a starting point of a trial and error procedure of choosing these matrixes, in order to obtain the desirable properties for the closed loop system. Weights reflect the relative importance given to the state with respect to the control effort.

Therefore, for our system, if one chooses large values for Q compared to the values in R , one gives a higher importance on the minimization of the mechanical weights and a lower importance to the command effort [13] [14].

IV. RESULTS

The simulations were done using MATLAB/SIMULINK software and the results proved good performances. The chosen operating point for the linearization of the system corresponds to the average value of the wind speed of 18m/s.

In Fig. 6 one can see the scheme that was used for the simulation.

The two reference variables, for the normalized electrical power P_{el_ref} and for the angular rotor speed ω_{T_ref} respectively, were chosen as constants with the appropriate values because the goal is to minimize the variations of the electrical power extracted around the nominal value of the

generator and we also want to keep the rotor speed constant.

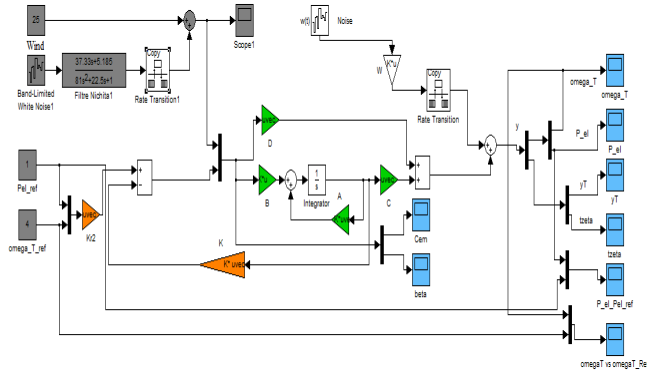

Fig. 6 The simulation of the system with LQR regulator

The weighting matrices mentioned in (9) and used for these simulations are

$$R = I, \quad Q = \begin{pmatrix} 0.3 & 0 & 0 & 0 \\ 0 & 400 & 0 & 0 \\ 0 & 0 & 1 & 0 \\ 0 & 0 & 0 & 1 \end{pmatrix}.$$

These values were chosen using the methods mentioned above and also based on the fact that they provided very good performance of the system in terms of achieving good responses and not very strong control actions.

The cost function was written in the following form:

$$J = \int_0^{\infty} (x^T \cdot Q_1 \cdot x + u^T \cdot R_1 \cdot u + 2 \cdot x^T \cdot S \cdot u), \text{ where}$$

$Q_1 = C_1^T \cdot Q \cdot C_1$, $R_1 = R + D_1^T \cdot Q \cdot D_1$, $S = C_1^T \cdot Q \cdot D_1$, and the matrices C_1 and D_1 being the truncated blocks from the system matrices C and D . These matrices contain the lines and columns from C and D corresponding to the control variables C_{em} and β .

The system is controllable and it does not contain unobservable modes. One important property of LQ regulators is that provided these conditions, they guarantee nominally stable closed loop systems.

In Fig. 7-10, one can see the results obtained in simulation.

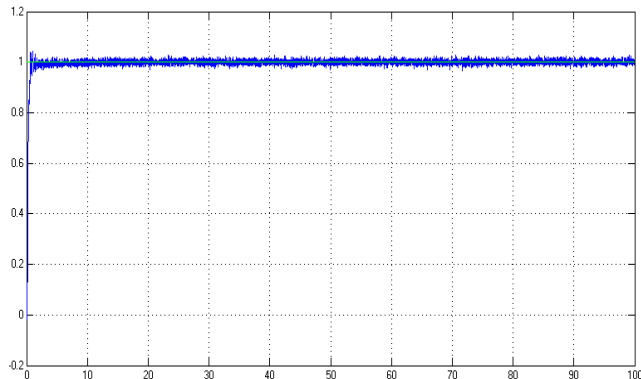

Fig. 7 The normalized electrical output power of the turbine

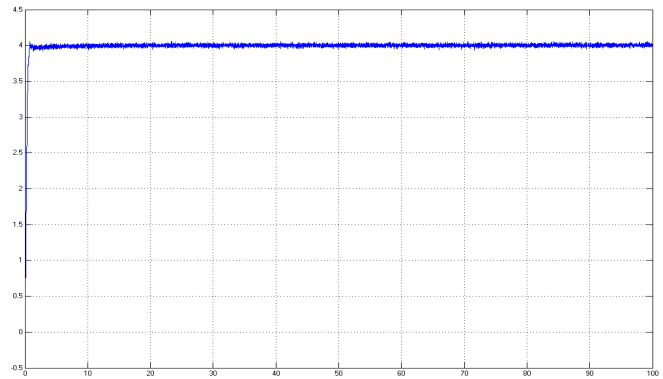

Fig. 8 The variation of the angular speed of the rotor

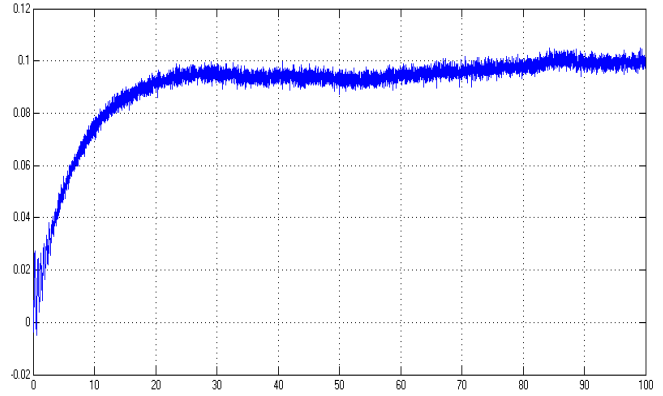

Fig. 9 The tower bending movement in the direction of the nacelle

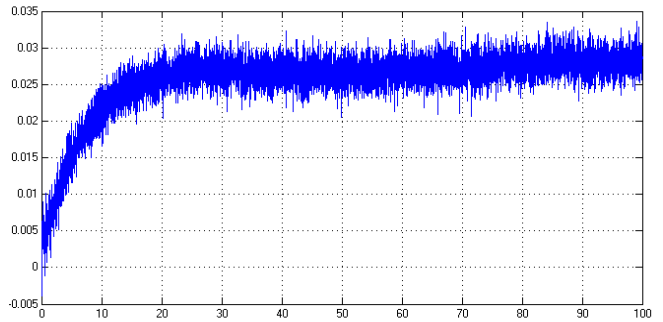

Fig. 10 The variation of the first flap mode of the blades

It can be observed that the electrical output power and the angular speed of the rotor manage to follow the reference and to maintain their nominal imposed values.

In the same time, the variables that were meant to be minimized, namely the first flap mode of the blades and the bending of the tower, have extremely small values. The blades have a deviation of about 5mm while the tower has an insignificant movement on the horizontal direction.

APPENDIX

THE NUMERICAL VALUES OF THE WIND TURBINE PARAMETERS		
Symbol	Physical measure	Value
J_t	<i>Turbine inertia</i>	214 000 Kg * m ²

J_g	<i>Generator inertia</i>	41 Kg * m ²
M_T	<i>Tower and nacelle mass</i>	35000 kg
M_p	<i>Blade mass</i>	3000 kg
k_p	<i>Blade Stiffness Coefficient</i>	1000 Kg * m ² /s ²
k_T	<i>Tower Stiffness Coefficient</i>	8500 Kg * m/s ²
k_A	<i>Drive Shaft Stiffness Coefficient</i>	11000 Kg * m ² /s ²
d_p	<i>Blade Damping coefficient</i>	10 000 Kg * m ² /s
d_T	<i>Tower Damping coefficient</i>	50 000 Kg * m/s
d_A	<i>Drive shaft damping coefficient</i>	60 000 Kg * m ² /s
r_p	<i>Distance from the rotor hub</i>	8 m
N	<i>Number of blades</i>	2
D	<i>The rotor diameter</i>	34 m
P_n	<i>Nominal Power</i>	400 kW
Ω_{nom}	<i>Nominal rotor speed</i>	4 rad/s
h	<i>Tower height</i>	47 m

REFERENCES

- [1] D. O. Kirk, "Optimal control theory-An Introduction", Dover Publications, 2004, pp. 3-5.
- [2] N.A Cutululis, I. Munteanu, E. Ceanga, "Optimal control structure for variable speed wind power system", The annals of "Dunarea de Jos" University of Galati, Fascicle III, pp 95-102, 2002.
- [3] A. D. Wright, "Modern control design for flexible wind turbines – Technical Report", NREL/TP-500-35816, July 2004, pp.23-26.
- [4] D. F. Bianchi, H. Battista, "Wind turbine control systems –Principles, Modeling and gain scheduling design", Springer-Verlag, London, 2002
- [5] L. Lupu, B. Boukhezzer, "Pitch and torque control strategy for variable speed wind turbines", Proceedings EWEC, Athens, 2006.
- [6] F. A. Vanegas, M. Zamacona, "Robust control solution of a wind turbine - A simulation study", International Master's Thesis in Information Technologies, Halmstadt University, February, 2008.
- [7] F. Lescher, P.Borne, "Robust gain scheduling controller for pitch regulated variable speed wind turbine", Studies in Informatics and Control, vol 14, No.4, pp 299-315, 2005.
- [8] M. Jelavic, I. Petrovic, "Design of a wind turbine pitch controller for loads and fatigue reduction", Electrical Engineering Institute, Proceedings of the European Wind Energy Conference & Exhibition – EWEC, Milan, Italy, 2007.
- [9] I. Munteanu, E. Ceanga, "Optimal control of wind energy systems – Towards a global approach", Springer, 2007.
- [10] B. D. O. Anderson, J. B. Moore, "Optimal control: Linear quadratic methods", Prentice Hall, Englewood Cliffs, NJ, 1990.
- [11] F. C. Callier, J. L. Willems, "Criterion for convergence of the solution of the Riccati differential equations", IEEE Trans. Automat. Contr. AC-26, pp. 1232-1242, 1981.
- [12] R. Sivan, H. Kwakernaak, "Linear optimal control systems", Wiley-Interscience, 1st edition, October 1972.
- [13] A. E. Bryson, "Applied linear optimal control – Examples and Algorithms", Cambridge University Press, 2002.
- [14] J. L. Hellerstein, Y. Diao, S. Parekh, D. M Tilbury, "Feedback control of computing systems", John Wiley & Sons, Inc., 2004.